

GEOMETRIC GEODESY

PART I

by

Richard H. Rapp

**The Ohio State University
Department of Geodetic Science and Surveying
1958 Neil Avenue
Columbus, Ohio 43210**

April 1991

© by Richard H. Rapp, 1984

Foreword

Since the precise shape of the earth was recognized in the 18th century to be an ellipsoid of revolution, classical geodetic positioning has been done using measurements on the surface of the earth that were ideally reduced to the ellipsoid for additional analysis through data adjustment. It is therefore important to understand the basic properties of the ellipsoid and curves on its surface that are pertinent to geodetic computations. It is the purpose of the material in this text to provide such information.

The information given here is primarily intended as a basis for a forty lecture hour course in Geometric Geodesy. In doing such a course not all the material given here can be covered except perhaps by reference. In many cases I have tried to give detailed derivations leading to the final result. Although this takes space and time, it is through the study of these derivations that the reader will obtain a deeper insight to the mathematics of the problem.

The development of the mathematical tools for analyzing the geometry of the ellipsoid for geodetic purposes has been carried out for several centuries. This book takes advantage of much previously derived material. Although one might believe that everything that needs to be derived, has been, this belief is false. Today, new techniques continue to be published to improve computational efficiency and accuracy. Such information has been included in this text where appropriate.

These notes have been developed from lectures given by the author at The Ohio State University over a number of years. Early versions of lecture notes were started in 1975 with minor revisions in succeeding years. These pages represent a substantial revision of the earlier sets of lecture notes. Comments from the students and the results of their computational efforts have been incorporated into this new version.

As indicated in the title, this work is Part I of a two part volume. Part II covers new topics in a depth similar to this text. Specifically, Part II discusses the following topics: Computations with Very Long Distances on the Ellipsoid; The Theory and Development of Geodetic Datums; Transformation Between Geodetic Datums; The Determination of the Size and Shape of the Earth; and Three-Dimensional Geodesy.

The author thanks Professor D.P. Hajela and M. Hanafy for providing the corrections to a draft version of this book. Ms. Laura Brumfield carried out the excellent typing of this volume.

TABLE OF CONTENTS

1.	Historical Perspective	1
2.	Useful Mathematical Procedures	6
	2.1 Taylor and Maclaurin Series	6
	2.2 The Binomial Series	7
	2.3 Series Inversion	8
	2.4 Summary of Trigonometric Expansions	9
	2.5 Multiple Angle Formulas	9
	2.6 Numerical Conversion Constants	11
3.	Properties of the Ellipsoid	12
	3.1 Introduction	12
	3.2 Geodetic Coordinates	16
	3.3 The Meridian Ellipse	17
	3.4 Relationships Between the Various Latitudes	24
	3.5 Radii of Curvature on the Ellipsoid	27
	3.51 The Radius of Curvature in the Meridian	28
	3.52 Radius of Curvature in the Prime Vertical	32
	3.53 The Radius of Curvature in the Normal Section Azimuth α	35
	3.6 Meridian Arc Lengths	36
	3.7 Length of a Parallel Arc	40
	3.8 Calculation of Areas on the Surface of an Ellipsoid	41
	3.9 Radii of Spherical Approximation to the Earth or Mean Radius of the Earth as a Sphere	43
	3.91 The Gaussian Mean Radius	43
	3.92 Radius of a Sphere Having the Mean of the Three Semi- Axes of the Ellipsoid	44
	3.93 Spherical Radius of Sphere Having the Same Area as the Ellipsoid	44
	3.94 Radius of a Sphere Having the Same Volume as the Ellipsoid	45
	3.10 Space Rectangular Coordinates	46
	3.11 An Alternate Form for the Equation of the Ellipsoid	47
4.	Curves on the Surface of the Ellipsoid	49
	4.1 Normal Sections	49
	4.11 Introduction	49
	4.12 The Separation Between Reciprocal Normal Sections	51
	4.13 Linear Separation of Reciprocal Normal Sections	55
	4.14 Azimuth separation of Reciprocal Normal Section	58
	4.15 The Elliptic Arc of a Normal Section	59

4.16	Azimuth Correction due to Height of Observed Point	61
4.17	The Dip Angle of the Chord	64
4.18	The Normal Section and Chord Length	66
4.19	The Normal Section in a Local Coordinate System	67
4.2	The Geodesic Curve	71
4.21	Local x, y, z Coordinates in Terms of the Geodesic	79
4.22	The Length of a Differential Arc of a Rotated Geodesic	81
4.23	Relationship Between the Geodesic and Chord Length	81
4.24	Comparison with the Normal Section	82
4.25	Difference Between the Normal Section and the Geodesic	85
4.3	The Great Elliptic Arc and the Curve of Alignment	87
4.4	Geometric Reduction of Measured Directions or Azimuths	87
5.	Solution of Spherical and Ellipsoidal Triangles	89
5.1	Spherical Excess	89
5.2	Solution of the Spherical Triangle by Legendre's Theorem	90
5.3	Solution of Spherical Triangles by Additaments	95
6.	Calculation of Geodetic Coordinates (Solutions of the Ellipsoidal Polar Triangle)	97
6.1	Introduction	97
6.2	Series Development in Powers of s	98
6.21	The Direct Problem	98
6.22	The Inverse Solution	103
6.3	The Puissant Formulas	104
6.31	The Direct Problem	104
6.32	The Inverse Problem	109
6.4	The Gauss Mid-Latitude Formulas	110
6.5	The Bowring Formulas	114
6.6	The Chord Method	116
6.61	The Inverse Problem	116
6.62	The Direct Problem	116
6.7	Accuracy of the Direct and Inverse Methods for Medium Length Lines	119
6.8	The Inverse Problem for Space Rectangular Coordinates	121
7.	Astro-Geodetic Information	127
7.1	Astronomic Coordinates	127
7.2	A Comparison of Astronomic and Geodetic Angular Quantities	130
7.21	The Correction of Directions for Deflection of the Vertical Effects	137
7.22	The Extended Laplace Equation	138

7.3	Astro-Geodetic Undulations of the Geoid	139
7.4	The Reduction of Measured Distances to the Ellipsoid	145
8.	Differential Formulas of the First and Second Type	149
8.1	Differential Formulas of the First Type	149
8.2	Differential Formulas of the Second Type	157
9.	Observation Equations for Triangulation, Trilateration Computations on the Ellipsoid	160
9.1	Direction and Distance Relationships	160
9.2	The Observation Equations	163
9.3	The Laplace Azimuth Observation Equation	164
9.4	Alternate Observation Equation Forms	165
10.	Geodetic Datums and Reference Ellipsoids	167
10.1	Datum Development	167
10.2	Datum Transformation	170
	References	174

LIST OF FIGURES

1.1	The Geometry of the Eratosthenes Measurement	1
1.2	The Shape of the Earth from the Early French Measurements	3
1.3	An Ellipse Flattened at the Poles	4
1.4	The Relationship Between the Ellipsoid, the Terrain, and the Geoid	5
3.1	The Basic Ellipse	12
3.2	Notation for the Ellipse	13
3.3	Coordinate Systems for the Ellipsoid	17
3.4	The Meridian Ellipse	18
3.5	The Reduced Latitude	18
3.6	The Geocentric Latitude	19
3.7	A Geometric Interpretation to W and V	22
3.8	A Portion of a Meridian Arc	29
3.9	Equatorial and Polar Meridian Radii of Curvature	31
3.10	Prime Vertical Radius of Curvature	32
3.11	Geometry for the Use of Menier's Theorem	33
3.12	Geometric Derivation for $N(A)$	34
3.13	Geometric Derivation of $N(B)$	34
3.14	Parallel Arc Length	40
3.15	Area Element on the Ellipsoid	41
3.16	The Geometry of a Point Above a Meridian Ellipse	46
3.17	A Local Coordinate System on the Ellipsoid	47
4.1	The Determination of the Distance On_A	50
4.2	A Normal Section "Triangle"	51
4.3	The Angle Between the Reciprocal Normal Sections at the Chord Connecting Them	51
4.4	Normal Section Geometry	52
4.5	An Approximation for the Spherical Arc σ	54
4.6	Geometry of the Linear Separation for the Normal Section	55
4.7	Linear Separation	56
4.8	Normal Section Azimuth Separation	58
4.9	The Elliptic Arc of a Normal Section	59
4.10	The Differential Element on the Elliptical Arc	60
4.11	Azimuth Effect for a Point Elevated above the Ellipsoid	62
4.12	Small Triangle for Height Effect Determination	63

4.13	The Dip Angle	65
4.14	Space Rectangular and Local Coordinate Systems	67
4.15	The Local Coordinate System	68
4.16	The Translated X, Y, Z Axes at Point A	69
4.17	The Geodesic Between Two Normal Sections	72
4.18	A Geodesic and Normal Section on a Highly Flattened ($f=1/3$) Ellipsoid	73
4.19	A Differential Figure on the Ellipsoid	73
4.20	The Geodesic in a Continuous Form	78
4.21	A View of a Continuous Geodesic from the North Pole Showing Consecutive Equator Crossings	78
4.22	The Ellipsoid Surface Containing a Differential Element of The Ellipsoid	79
4.23	The Geodesic Lying Between Two Normal Sections	83
4.24	Determination of the Azimuth Difference Between a Normal Section and a Geodesic	83
4.25	Differential Relationship Between Normal Section and Geodesic Lengths	85
4.26	The Curve of Alignment	87
5.1	Spherical and Planar Triangles	90
5.2	Triangles for the Additament Method	95
6.1	The Polar Ellipsoidal Triangle	97
6.2	the Puissant Approximation for Latitude Determination	104
6.3	The Puissant Approximation for Longitude Determination	107
6.4	Polar Triangles Solved through the Gauss-Mid-Latitude Formulas	110
6.5	Approximate Determination of the "Dip Angle"	118
6.6	A Meridian Section Showing a Point Above the Ellipsoid	121
6.7	Meridian Ellipse for the Bowring Derivation	123
6.8	Geometry for the Determination of h	124
7.1	Measured Astronomic Quantities	129
7.2	The Celestial Sphere Showing astronomic and Geodetic Quantities	131
7.3	Determination of the Zenith Distances	136
7.4	Location of the Geoid with Respect to the Reference Ellipsoid of a Specific Datum	139
7.5	Astro-Geodetic Geoid Profile in Azimuth α	140
7.6	Astro-Geodetic Grid	141
7.7	The Smoothed Astro-Geodetic Geoid in the United States	143

7.8	The Astro-Geodetic Geoid in Land Areas of the World Referred to the World Geodetic System 1972	144
7.9	Baseline Reduction	145
7.10	Reduction of Chord Distances to the Ellipsoid	147
8.1	The Differential Effect of a Length Extension	150
8.2	The Differential Effect of an Azimuth Change	152
8.3	The Back Azimuth Change due to $d\alpha_{12}$	153
8.4	Detailed Back Azimuth Change Effects	154
9.1	Differential Movements of Line Endpoints	161
10.1	Major Geodetic Datum Blocks	168
10.2	A Satellite (S) and Datum (D) System with Parallel Axes	170

1. HISTORICAL PERSPECTIVE

The search for the size and shape of the earth has a long and interesting history. Although today we have no problem in viewing the earth as an approximately spherical body, this situation did not always exist.

Early recorded thoughts indicated (e.g. Homer 9th century B.C.) that the earth was a flat disk supporting a hemispherical sky. With this view there would be only one horizon with the time and length of day being independent of location.

In the sixth century B.C. Pythagoras suggested that the earth was spherical in shape. This suggestion was made on the basis that a sphere was considered a perfect form, and not by deduction from observations.

Finally in the fourth century B.C. Aristotle gave arguments that would support the hypothesis that the earth must be spherical in shape. Some specific reasons that were mentioned include: a) the changing horizon as one travels in various directions; b) the round shadow of the earth that was observed in lunar eclipses; c) the observation of a ship at sea where more (or less) of the ship is seen as the ship approaches (or goes away).

The next developments are now related to the determination of the size of the spherical earth. Although some determinations may have been made before, the first attempt at a precise determination (for the time) is ascribed to Eratosthenes of Egypt. The developments in Egypt were a natural follow up to the developments made in surveying for the purpose of property location.

In 230 B.C. Eratosthenes carried out his famous experiment to determine the size of the spherical earth. To do this he made observations at two cities in Egypt, Alexandria and Syene (now Aswan), that were located almost on the same meridian. At the southern city of Syene, the sun shone directly into a deep well at summer solstice, implying that the sun was directly overhead. In Alexandria, the length of a shadow cast by the gnomon on a sun dial was measured at noon. This length was $1/50$ of 360° ($7^\circ 12'$) and was the angle subtended at the center of the earth between Syene and Alexandria, as shown in Figure 1.1.

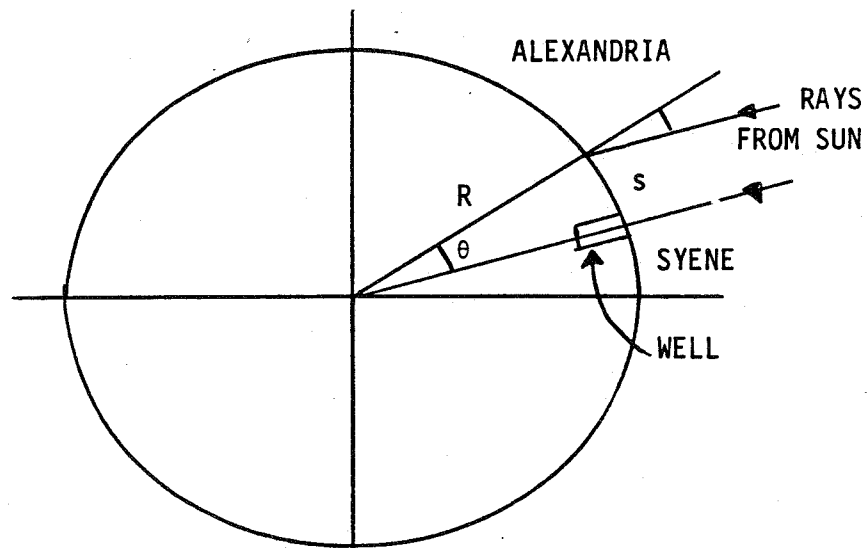

Figure 1.1
The Geometry of the Eratosthenes Measurement

If the distance, s , between the two cities could be determined, the circumference of the earth would be s/θ if θ were expressed as a fraction of a circle. Alternately the radius of the earth would be s/θ if θ were now in radians.

The determination of the distance between the two cities was a difficult matter. The most quoted distance as used by Eratosthenes is the rounded value of 5000 stadia. This distance most probably was determined by Egyptian step counters "who determined distances for Egyptian maps". With this value the circumference of the earth was 250,000 stadia. Other estimates gave the circumference as determined by Eratosthenes to be 252,000 stadia which may have been based on a more specific distance.

In order to compare the Eratosthenes result with current estimates we need to convert the stadia length unit to meters. A number of different conversion factors have been used. One widely used conversion is that 1 stadium equals 157.5 meters. This would imply a radius of 6317 km which is 1% smaller than the actual average radius. We thus conclude that the Eratosthenes results were very accurate for the day, and remained the most accurate estimate for many centuries.

The method used by Eratosthenes was subject to a number of errors however. For example, Alexandria and Syene were not actually on the same meridian, nor was the sun actually **directly** overhead at the time of the measurement. Nevertheless, the result obtained demonstrated the method quite well.

The Eratosthenes type experiment was repeated by Posidonius in the first century B.C. In this computation an arc along a meridian was measured from Rhodes to Alexandria. The angular separation was determined by using the star Canopus. When the star was on the horizon at Rhodes, it was at an angle of $1/48$ of a full circle at Alexandria. Therefore the angular separation between the two cities was 7.5° . The distance between the cities was determined to be 5000 stadia from sailing ship measurements. This implied a radius 11% less than today's estimate. It turned out that both the angular measurement and the distance measurement were improved but in a proportional way so that the result was approximately correct. On the other hand there is some discussion that Posidonius did not actually make the measurement described above, but perhaps just gave a talk describing the method in a simple way.

For the next few centuries little work was done in studies related to the figure of the earth. In the ninth century Caliph al-Mamun had a new measurement made near Bagdad, Iraq in the plain of the Euphrates River. In this application wooden rods were used to measure the length of a degree of latitude. After considering the customary units conversion problem, the measurements yielded a radius too large by 10%.

In the 17th century, Snellius carried out measurements along a meridian in the Netherlands. For the first time for these purposes he used a triangulation procedure measuring angles with one-minute precision. Combining this measurement with astronomic latitudes made at the endpoints of the meridian arc, Snellius determined the size of the spherical earth using the basic method of Eratosthenes. A second determination of the radius (or actually the quadrant of the meridian) gave a result too small by 3.4%. Additional work was done by Musschenbrock (Snellius' successor) who obtained an improved earth radius.

It was in this time period that the era of spherical geodesy started to fall. This actually started in 1666 when the Académie Royale des Sciences was established to carry out measurements for the preparation of an accurate map of France and the determination of the size of the earth. In 1669 Picard started the measurements of a meridian arc near Paris. Between 1683-1716 the arc was extended to the south to Collioure and to Dunkirk to the north by a team led by Lahire and Dominique and Jacques Cassini. The computations made from these measurements indicated that the length of the meridian arc was smaller towards the poles. This tentative conclusion conflicted with the notion that the earth was spherical in shape. In fact it implied that the earth was pointed towards the poles as shown in Figure 1.2.

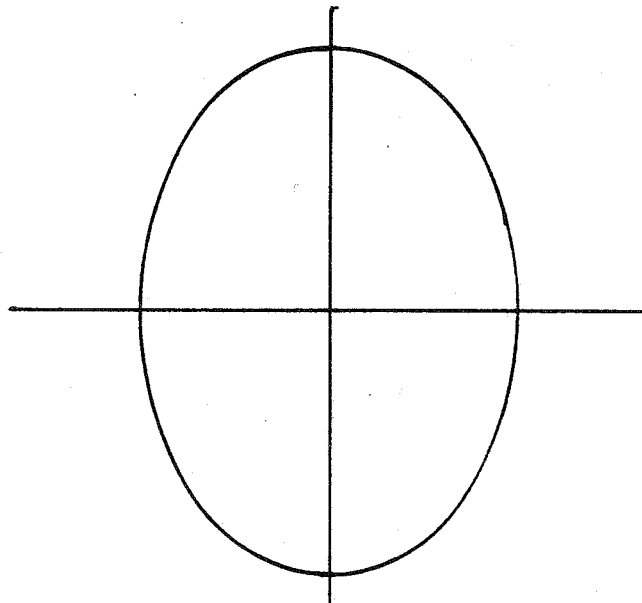

Figure 1.2
The Shape of the Earth from the Early French Measurements

These measurements also conflicted with the theories being proposed by Isaac Newton of England. Newton, in considering his attraction theory, postulated that the rotating earth should be flattened in the polar areas. This would imply that as one travels towards the equator we go farther from the center of the earth. The effect of this was actually observed by Richer (in 1672) on pendulum clocks that kept good time in Paris, but lost $2\frac{1}{2}$ minutes per day when brought to Cayene, Guiana, near the equator in South America. This time lost was consistent with Newton's theory because of the decrease of gravity in going from Paris to Cayene.

In order to resolve this conflict, the Académie Royale des Sciences established two geodetic survey missions. One expedition (1734-1741) was sent to Peru (now Ecuador) at a latitude of about -1.5° under the direction of Godin, La Condamine and Bouguer. The second expedition (1736-1737) was sent to Lapland (at a latitude of about 66.3°) under the direction of Maupertuis and Clairaut. The results of these measurements indicated that the length of a 1° meridian was greater in the polar regions than in the equatorial regions. This agreed with

the theories of Newton and implied that the earth's figure could be represented by an ellipsoid slightly flattened at the poles as shown in Figure 1.3.

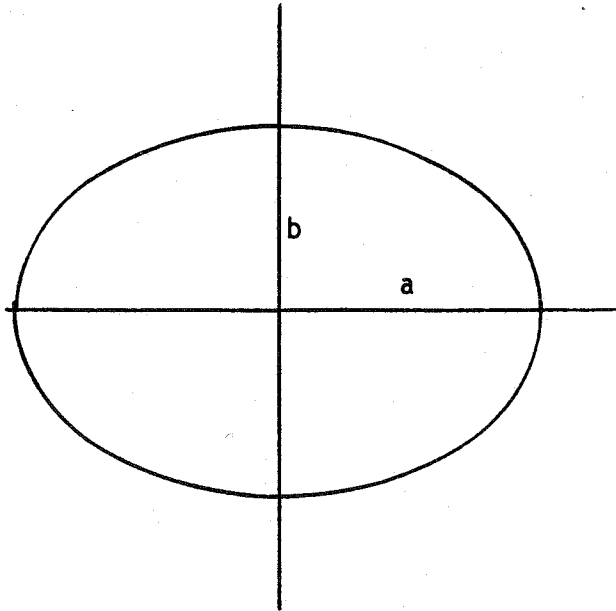

Figure 1.3
An Ellipse Flattened at the Poles

A current estimate of the equatorial radius (a) of the earth is 6378137 meters. The flattening ($f = (a-b)/a$) is approximately $1/298.257$ which implies a difference of 21.7 km between the equatorial radius and the polar radius.

Measurements were made by others (e.g. Svanberg, (1805) in Sweden, Lacaille (1751) in South Africa, Gauss (1821-1823), Bessel (1831-1838)) to verify and improve the knowledge of the size and now, the shape of the earth. Studies have continued today to better refine this knowledge. As improved measuring techniques became available it became more important to define more exactly what we mean by the Figure of the Earth.

In order to do this we consider the actual topographic surface of the earth, and a surface closely associated with the ocean surface. We recognize that the oceans comprise approximately 70% of the surface area of the earth. It is therefore appropriate to visualize the figure of the earth as that of the ocean surface. In 1872/3 Listing introduced the concept of the geoid as the surface of the undisturbed sea and its continuation into the continents. The ellipsoid of previous studies now became an approximation to the geoid.

In 1884 Helmert defined more precisely the geoid identifying it with an ocean with no disturbances such as would be caused by tides, winds, waves, temperature, pressure, and salinity differences, etc. This geoid was considered to be an equipotential surface of the earth's gravity field. The geoid in the continental areas was to be visualized by the water level in infinitely small canals in the land.

Unfortunately the definition of the geoid given above is not fully realizable. This is so because the ocean surface is a dynamic surface constantly changing due to many currents etc. However these effects are generally at the one meter level so that for many purposes we can identify mean sea level with the geoid.

We again point out that the ellipsoid is used now to approximate the geoid. Although there are a number of different kinds of ellipsoids, the one most commonly dealt with in geodesy is an ellipsoid of revolution (about the minor axis) that is symmetric with respect to the equator. Another ellipsoid is a tri-axial ellipsoid in which the equator is an ellipse. However, computations on a tri-axial ellipsoid are quite complicated with respect to those of the bi-axial symmetric rotational ellipsoid. Consequently in this discussion of Geometric Geodesy we will concentrate on the geometry and geodetic importance of the ellipsoid.

The various surfaces that we have discussed are shown in the meridian section of the earth represented in Figure 1.4.

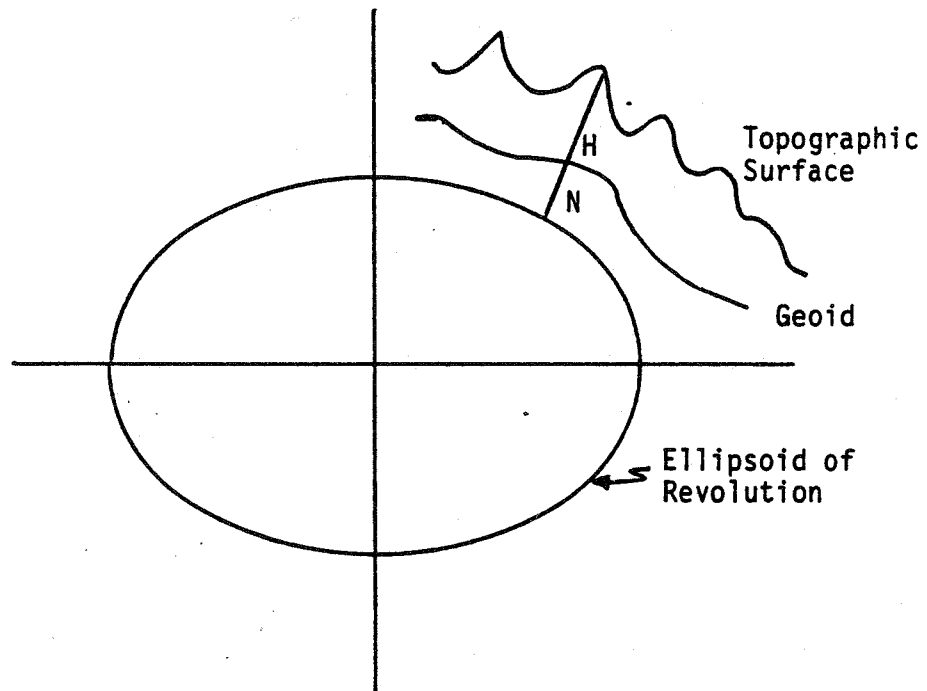

Figure 1.4
The Relationship Between the Ellipsoid, the Terrain, and the Geoid

We should put into perspective the magnitudes of the various quantities of interest. Recall that the equatorial radius of the earth is approximately 6378137 meters. With respect to an ellipsoid whose center is at the center of the earth the root mean square geoid undulation (N) is ± 30 m with the extreme value of approximately -110 m. And finally the terrain, which has a maximum elevation with respect to mean sea level of about 9 km.

The historical information described in this section has been based on two papers by Irene Fischer (1975a, 1975b).

2. USEFUL MATHEMATICAL PROCEDURES

In the development of certain equations in the text to follow, it will be useful to call on certain standard mathematical procedures involving series expansions and trigonometric identities. The most widely used are now discussed.

2.1 Taylor and Maclaurin Series

A function $f(x)$ can be expanded about a point x_0 using a Taylor series:

$$f(x) = f(x_0) + (x-x_0) f'(x_0) + \frac{(x-x_0)^2}{2!} f''(x_0) + \frac{(x-x_0)^3}{3!} f'''(x_0) + \dots (2.1)$$

where $f'(x_0)$ is the first derivative of $f(x)$ evaluated at x_0 and so forth for the other prime terms. In principle one must check for the convergence of this series, but for most geometric geodesy applications convergence will be rapid.

In some cases it is convenient to let $x-x_0 = h$ and $x=x_0$ so that (2.1) becomes;

$$f(x+h) = f(x) + hf'(x) + \frac{h^2}{2!} f''(x) + \frac{h^3}{3!} f'''(x) + \dots (2.2)$$

As an example consider $f(x) = \sin x$. Applying (2.2) we have:

$$\sin(x+h) = \sin x + h \cos x - \frac{h^2}{2} \sin x - \frac{h^3}{6} \cos x + \frac{h^4}{24} \sin x + \dots (2.3)$$

A special case of the Taylor series is the Maclaurin found from (2.1) by letting $x_0 = 0$ so that we have:

$$f(x) = f(0) + xf'(0) + \frac{x^2}{2!} f''(0) + \frac{x^3}{3!} f'''(0) + \dots (2.4)$$

As an example again let $f(x) = \sin x$. Then (2.4) becomes:

$$\sin x = x - \frac{x^3}{3!} + \frac{x^5}{5!} - \frac{x^7}{7!} + \dots (2.5)$$

2.2 The Binomial Series

Another useful series is the binomial series which can be written as:

$$(1 \pm x)^n = 1 \pm nx + \frac{n(n-1)}{2!} x^2 \pm \frac{n(n-1)(n-2)}{3!} x^3 + \dots \quad (2.6)$$

The coefficients of x , x^2 , x^3 , etc. are called binomial coefficients. The binomial series exists for integral or fractional positive or negative exponents and always converges if $x < 1$. Useful expressions following from the binomial series are:

$$\frac{1}{1-x} = 1 + x + x^2 + x^3 + x^4 + \dots$$

$$\frac{1}{1+x} = 1 - x + x^2 - x^3 + x^4 - \dots$$

$$\frac{1}{(1+x)^2} = 1 - 2x + 3x^2 - 4x^3 + 5x^4 - \dots$$

$$\frac{1}{(1-x)^2} = 1 + 2x + 3x^2 + 4x^3 + 5x^4 + \dots$$

(2.7)

$$\sqrt{1+x} = 1 + \frac{1}{2}x - \frac{1}{8}x^2 + \frac{1}{16}x^3 - \frac{5}{128}x^4 + \frac{7}{256}x^5 - \frac{21}{1024}x^6 + \frac{33}{2048}x^7 - \dots$$

$$\sqrt{1-x} = 1 - \frac{1}{2}x - \frac{1}{8}x^2 - \frac{1}{16}x^3 - \frac{5}{128}x^4 - \dots$$

$$\frac{1}{\sqrt{1+x}} = 1 - \frac{1}{2}x + \frac{3}{8}x^2 - \frac{5}{16}x^3 + \frac{35}{128}x^4 - \frac{63}{256}x^5 + \frac{231}{1024}x^6 - \frac{429}{2048}x^7 + \dots$$

$$\frac{1}{\sqrt{1-x}} = 1 + \frac{1}{2}x + \frac{3}{8}x^2 + \frac{5}{16}x^3 + \frac{35}{128}x^4 + \dots$$

$$\sqrt{1-x^2} = 1 - \frac{1}{2}x^2 - \frac{1}{8}x^4 - \frac{1}{16}x^6 - \frac{5}{128}x^8 - \frac{7}{256}x^{10} - \dots$$

$$\frac{1}{\sqrt{1-x^2}} = 1 + \frac{1}{2}x^2 + \frac{3}{8}x^4 + \frac{5}{16}x^6 + \frac{35}{128}x^8 + \frac{63}{256}x^{10} + \dots$$

2.3 Series Inversion

Another important series relates to series inversion. One type relates to the inversion of convergent algebraic series, while another relates to the inversion of trigonometric series. Consider first the following power series:

$$y = a_1x + a_2x^2 + a_3x^3 + a_4x^4 + \dots \quad (2.8)$$

The inversion of this yields the general form:

$$x = A_1y + A_2y^2 + A_3y^3 + A_4y^4 + \dots \quad (2.9)$$

where:

$$A_1 = \frac{1}{a_1};$$

$$A_2 = -\frac{a_2}{a_1^3};$$

$$A_3 = \frac{1}{a_1^5} (2a_2^2 - a_1a_3); \quad (2.10)$$

$$A_4 = \frac{1}{a_1^7} (5a_1a_2a_3 - a_1^2a_4 - 5a_2^3);$$

$$A_5 = \frac{1}{a_1^9} (6a_1^2a_2a_4 + 3a_1^2a_3^2 + 14a_2^4 - a_1^3a_5 - 21a_1a_2^2a_3).$$

Consider next an expansion written in the following form (Ganshin, 1967, p. 9):

$$\tan y = p \tan x \quad (2.11)$$

Then:

$$y - x = q \sin 2x + \frac{1}{2} q^2 \sin 4x + \frac{1}{3} q^3 \sin 6x + \dots \quad (2.12)$$

where:

$$q = \frac{p-1}{p+1}$$

Another important formula is the following:

$$y = x + P_2 \sin 2x + P_4 \sin 4x + P_6 \sin 6x + \dots$$

The inversion of this equation is:

$$x = y + \dot{P}_2 \sin 2y + \dot{P}_4 \sin 4y + \dot{P}_6 \sin 6y + \dots$$

where (Ganshin, 1967, p.32):

$$\dot{P}_2 = -P_2 - P_2 P_4 + \frac{1}{2} P_2^3 - P_6 P_4 + P_2 P_4^2 - \frac{1}{2} P_2^2 P_6 + \frac{1}{3} P_2^3 P_4 - \frac{1}{12} P_2^5 + \dots$$

$$\dot{P}_4 = -P_4 + P_2^2 - 2P_2 P_6 + 4P_2^2 P_4 - \frac{4}{3} P_2^4 + \dots$$

$$\dot{P}_6 = -P_6 + 3P_2 P_4 - \frac{3}{2} P_2^3 - 3P_2 P_8 + \frac{9}{2} P_2 P_4^2 + 9P_2^2 P_6 - \frac{27}{2} P_2^3 P_4 + \frac{27}{8} P_2^5 + \dots$$

$$\dot{P}_8 = -P_8 + 2P_2^2 + 4P_2 P_6 - 8P_2^2 P_4 + \frac{8}{3} P_2^4 + \dots$$

$$\dot{P}_{10} = -P_{10} + 5P_4 P_6 + 5P_2 P_8 - \frac{25}{2} P_2^2 P_6 - \frac{25}{2} P_2 P_4^2 + \frac{125}{6} P_2^2 P_4 - \frac{125}{4} P_2^5 + \dots$$

2.4 Summary of Trigonometric Expansions

Using the Maclaurin series previously discussed the following expansions can be derived where x is an angle in radians:

$$\sin x = x - \frac{x^3}{3!} + \frac{x^5}{5!} - \frac{x^7}{7!} + \dots \quad (2.13)$$

$$\cos x = 1 - \frac{x^2}{2!} + \frac{x^4}{4!} - \frac{x^6}{6!} + \dots \quad (2.14)$$

$$\tan x = x + \frac{x^3}{3} + \frac{2x^5}{15} + \frac{17x^7}{315} + \dots \quad (2.15)$$

$$x = \sin^{-1} y = y + \frac{y^3}{6} + \frac{3y^5}{40} + \frac{5y^7}{112} + \dots \quad (2.16)$$

$$x = \tan^{-1} y = y - \frac{y^3}{3} + \frac{y^5}{5} - \frac{y^7}{7} + \dots \quad (2.17)$$

2.5 Multiple Angle Formulas

For a number of applications it is convenient to have formulas relating powers of the $\sin x$ or $\cos x$ to multiple angle formulas. Such formulas are as follows:

$$\sin^2 x = \frac{1}{2} - \frac{1}{2} \cos 2x$$

$$\sin^3 x = \frac{3}{4} \sin x - \frac{1}{4} \sin 3x$$

$$\sin^4 x = \frac{3}{8} - \frac{1}{2} \cos 2x + \frac{1}{8} \cos 4x$$

$$\sin^5 x = \frac{5}{8} \sin x - \frac{5}{16} \sin 3x + \frac{1}{16} \sin 5x$$

$$\sin^6 x = \frac{5}{16} - \frac{15}{32} \cos 2x + \frac{3}{16} \cos 4x - \frac{1}{32} \cos 6x$$

(2.18)

$$\sin^7 x = \frac{35}{64} \sin x - \frac{21}{64} \sin 3x + \frac{7}{64} \sin 5x - \frac{1}{64} \sin 7x$$

$$\sin^8 x = \frac{35}{128} - \frac{7}{16} \cos 2x + \frac{7}{32} \cos 4x - \frac{1}{16} \cos 6x + \frac{1}{128} \cos 8x$$

$$\sin^9 x = \frac{63}{128} \sin x - \frac{21}{64} \sin 3x + \frac{9}{64} \sin 5x - \frac{9}{256} \sin 7x + \frac{1}{256} \sin 9x$$

$$\sin^{10} x = \frac{63}{256} - \frac{105}{256} \cos 2x + \frac{15}{64} \cos 4x - \frac{45}{512} \cos 6x + \frac{5}{256} \cos 8x - \frac{1}{512} \cos 10x$$

$$\cos^2 x = \frac{1}{2} + \frac{1}{2} \cos 2x$$

$$\cos^3 x = \frac{3}{4} \cos x + \frac{1}{4} \cos 3x$$

$$\cos^4 x = \frac{3}{8} + \frac{1}{2} \cos 2x + \frac{1}{8} \cos 4x$$

$$\cos^5 x = \frac{5}{8} \cos x + \frac{5}{16} \cos 3x + \frac{1}{16} \cos 5x$$

$$\cos^6 x = \frac{5}{16} + \frac{15}{32} \cos 2x + \frac{3}{16} \cos 4x + \frac{1}{32} \cos 6x$$

(2.19)

$$\cos^7 x = \frac{35}{64} \cos x + \frac{21}{64} \cos 3x + \frac{7}{64} \cos 5x + \frac{1}{64} \cos 7x$$

$$\cos^8 x = \frac{35}{128} + \frac{7}{16} \cos 2x + \frac{7}{32} \cos 4x + \frac{1}{16} \cos 6x + \frac{1}{128} \cos 8x$$

$$\cos^9 x = \frac{63}{128} \cos x + \frac{21}{64} \cos 3x + \frac{9}{64} \cos 5x + \frac{9}{256} \cos 7x + \frac{1}{256} \cos 9x$$

$$\cos^{10} x = \frac{63}{256} + \frac{105}{256} \cos 2x + \frac{15}{64} \cos 4x + \frac{45}{512} \cos 6x + \frac{5}{256} \cos 8x + \frac{1}{512} \cos 10x$$

$$\sin 2x = 2 \sin x \cos x$$

$$\sin 3x = 3 \sin x \cos^2 x - \sin^3 x$$

$$\sin 4x = 4 \sin x \cos^3 x - 4 \sin^3 x \cos x$$

$$\sin 5x = 5 \sin x \cos^4 x - 10 \sin^3 x \cos^2 x + \sin^5 x$$

(2.20)

$$\sin 6x = 6 \sin x \cos^5 x - 20 \sin^3 x \cos^3 x + 6 \sin^5 x \cos x$$

$$\sin 7x = 7 \sin x \cos^6 x - 35 \sin^3 x \cos^4 x + 21 \sin^5 x \cos^2 x - \sin^7 x$$

$$\sin 8x = 8 \sin x \cos^7 x - 56 \sin^3 x \cos^5 x + 56 \sin^5 x \cos^3 x - 8 \sin^7 x \cos x$$

$$\sin 9x = 9 \sin x \cos^8 x - 84 \sin^3 x \cos^6 x + 126 \sin^5 x \cos^4 x - 36 \sin^7 x \cos^2 x + \sin^9 x$$

$$\sin 10x = 10 \sin x \cos^9 x - 120 \sin^3 x \cos^7 x + 252 \sin^5 x \cos^5 x$$

$$-120 \sin^7 x \cos^3 x + 10 \sin^9 x \cos x$$

$$\begin{aligned}
\cos 2x &= \cos^2 x - \sin^2 x \\
\cos 3x &= \cos^3 x - 3 \cos x \sin^2 x \\
\cos 4x &= \cos^4 x - 6 \cos^2 x \sin^2 x + \sin^4 x \\
\cos 5x &= \cos^5 x - 10 \cos^3 x \sin^2 x + 5 \cos x \sin^4 x \\
\cos 6x &= \cos^6 x - 15 \cos^4 x \sin^2 x + 15 \cos^2 x \sin^4 x - \sin^6 x \\
\cos 7x &= \cos^7 x - 21 \cos^5 x \sin^2 x + 35 \cos^3 x \sin^4 x - 7 \cos x \sin^6 x \\
\cos 8x &= \cos^8 x - 28 \cos^6 x \sin^2 x + 70 \cos^4 x \sin^4 x - 28 \cos^2 x \sin^6 x \\
&\quad + \sin^8 x \\
\cos 9x &= \cos^9 x - 36 \cos^7 x \sin^2 x + 126 \cos^5 x \sin^4 x - 84 \cos^3 x \sin^6 x \\
&\quad + 9 \cos x \sin^8 x \\
\cos 10x &= \cos^{10} x - 45 \cos^8 x \sin^2 x + 210 \cos^6 x \sin^4 x - 210 \cos^4 x \sin^6 x \\
&\quad + 45 \cos^2 x \sin^8 x - \sin^{10} x.
\end{aligned}
\tag{2.21}$$

Another useful identity is the following for the two angles X and Y :

$$\sin nX - \sin nY = 2 \cos \frac{n}{2} (X + Y) \sin \frac{n}{2} (X - Y) \tag{2.22}$$

$$\cos nX - \cos nY = -2 \sin \frac{n}{2} (X + Y) \sin \frac{n}{2} (X - Y) \tag{2.23}$$

2.6 Numerical Conversion Constants

For computations it is necessary to have certain conversion factors. Selected values are as follows:

π	3.14159 26535 8979 32384 62643
1 radian	57°29'57.79513 08232 08767 98155
1 radian	206264"80624 70963 55156

3. PROPERTIES OF THE ELLIPSOID

3.1 Introduction

As discussed in section 1 for many computations in geometric geodesy we deal with the geometry of an ellipsoid of revolution. This ellipsoid is formed by taking an ellipse and rotating it about its minor axis. Let this ellipse be as shown in Figure 3.1.

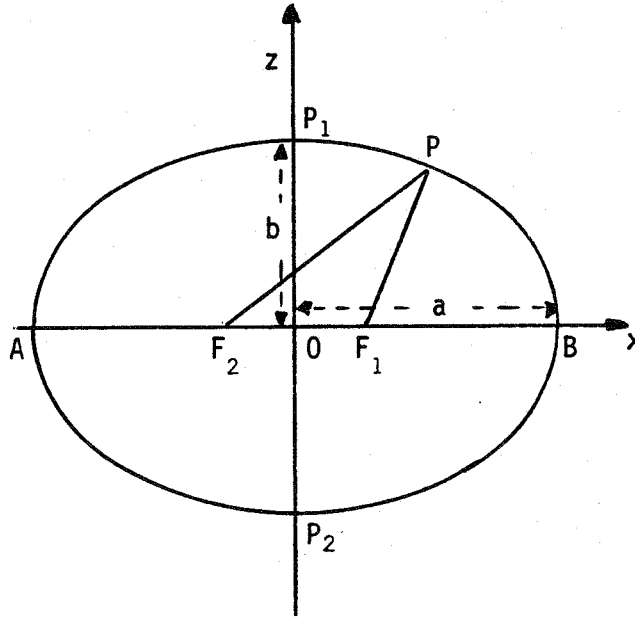

Figure 3.1
The Basic Ellipse

In this figure we have:

F_1, F_2 ; foci of the ellipse AP_2BP_1 ;
 O = center of the ellipse;
 $OA = OB = a$ = semi-major axis of the ellipse;
 $OP_1 = OP_2 = b$ = semi-minor axis of the ellipse;
 P_1P_2 is the minor axis of this ellipse while P
is an arbitrary point on the ellipse.

From the definition of an ellipse as a locus of a point which moves so that the sum of its distances from two fixed points is a constant we have:

$$F_2P + F_1P = a \text{ constant} \quad (3.1)$$

If we let P go to B , and then to A , we can find that:

$$F_2P + F_1P = 2a \quad (3.2)$$

If we now let P go to P_1 , and note that $F_2P_1 = F_1P_1$ we must have from equation (3.2) that $F_2P_1 = F_1P_1 = a$, the semi-major axis. This information is shown in the following figure:

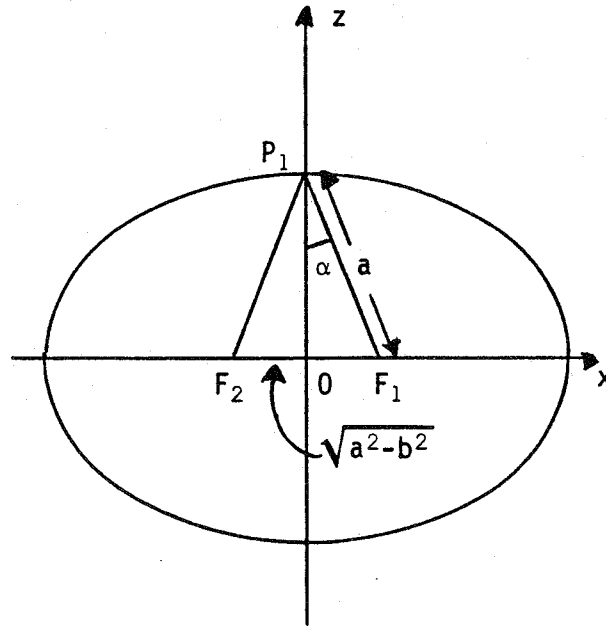

Figure 3.2
Notation for the Ellipse

We are now in a position to define some of the fundamental parameters of this ellipse. We have the following:

- 1) the polar flattening, f :

$$f \equiv \frac{a - b}{a} \quad (3.3)$$

- 2) the first eccentricity, e :

$$e \equiv \frac{OF_1}{a} = \frac{\sqrt{a^2 - b^2}}{a}; \quad e^2 = \frac{a^2 - b^2}{a^2} \quad (3.4)$$

- 3) the second eccentricity, e' :

$$e' \equiv \frac{OF_1}{b} = \frac{\sqrt{a^2 - b^2}}{b}; \quad e'^2 = \frac{a^2 - b^2}{b^2} \quad (3.5)$$

- 4) the angular eccentricity, α (see Figure 3.2); α is the angle at P_1 between the minor axis and a line drawn from P , to either F_2 or F_1 . We have:

$$\cos \alpha = \frac{b}{a} = 1 - f \quad (3.6)$$

$$\sin \alpha = \frac{OF_1}{a} = e \quad (3.7)$$

$$\tan \alpha = \frac{OF_1}{b} = e' \quad (3.8)$$

- 5) the linear eccentricity, E ;

$$E = ae \quad (3.9)$$

Two other quantities often used are:

$$m \equiv \frac{a^2 - b^2}{a^2 + b^2} \quad (3.10)$$

$$n \equiv \frac{a - b}{a + b} \quad (3.11)$$

In some books the quantity m is designated as e''^2

The basic parameters, a , b , f , e , e' , α , m , n are interrelated through equations that can be fairly readily derived. For example, consider the relationship between f and e' . From (3.4) we have:

$$e^2 = 1 - \frac{b^2}{a^2} \quad (3.12)$$

From (3.3):

$$\frac{b}{a} = 1 - f \quad (3.13)$$

which is substituted into (3.12) to find:

$$e^2 = 2f - f^2 \quad (3.14)$$

Other relationships of interest are as follows (Gan'shin, 1967):

$$e^2 = \frac{e'^2}{1+e'^2} = \frac{4n}{(1+n)^2} = \frac{2m}{1+m} \quad (3.15)$$

$$e'^2 = \frac{e^2}{1-e^2} \quad (3.16)$$

$$(1-e^2)(1+e'^2) = 1 \quad (3.17)$$

$$\frac{b}{a} = (1-f) = \sqrt{1-e^2} = \frac{e}{e'} = \frac{1}{\sqrt{1+e'^2}} = \frac{1-n}{1+n} = \sqrt{\frac{1-m}{1+m}} \quad (3.18)$$

$$n = \frac{f}{2-f} = \frac{1-\sqrt{1-e^2}}{1+\sqrt{1-e^2}} \quad (3.19)$$

$$m = \frac{2f-f^2}{1+(1-f)^2} = \frac{2n}{1+n^2} \quad (3.20)$$

In addition it is sometimes convenient to have some series expressions relating certain quantities. For example, we have the following (Gan'shin, 1967):

$$n = (1/2)f + (1/4)f^2 + (1/8)f^3 + (1/16)f^4 + (1/32)f^5 +$$

$$n = (1/4)e^2 + (1/8)e^4 + (5/64)e^6 + (7/128)e^8 + (21/512)e^{10} +$$

$$n = (1/2)m + (1/8)m^3 + (1/16)m^5 +$$

$$m = f + (1/2)f^2 - (1/4)f^4 - (1/4)f^5 +$$

$$m = (1/2)e^2 + (1/4)e^4 + (1/8)e^6 + (1/16)e^8 + (1/32)e^{10} +$$

$$m = 2n - 2n^3 + 2n^5 +$$

$$e'^2 = 2f + 3f^2 + 4f^3 + 5f^4 + 6f^5 +$$

$$e'^2 = 4n + 8n^2 + 12n^3 + 16n^4 + 20n^5 +$$

$$e'^2 = 2m + 2m^2 + 2m^3 + 2m^4 + 2m^5 +$$

The numerical values for these quantities depend on the fundamental definition of a size (a) and shape (usually f) parameter. Many different ellipsoids have been used in the past. Currently the system of constants recommended by the International Association of Geodesy is the Geodetic Reference System 1980 (Moritz, 1980). For this system, quantities of geometric interest are the following:

$$\begin{aligned}
 a &= 6378137 \text{ m (exact)} \\
 b &= 6356752.3141 \text{ m} \\
 E &= 521854.0097 \text{ m} \\
 c &= 6399593.6259 \text{ m} \\
 e^2 &= 0.00669438002290 \\
 e'^2 &= 0.00673949677548 \\
 f &= 0.00335281068118 \\
 f^{-1} &= 298.257222101 \\
 n &= 0.001679220395 \\
 m &= 0.003358431319 \\
 Q &= 10001965.7293 \text{ m} \\
 R_1 &= 6371008.7714 \text{ m} \\
 R_2 &= 6371007.1810 \text{ m} \\
 R_3 &= 6371000.7900 \text{ m}
 \end{aligned}$$

In the above constants Q is the length of a meridian quadrant, R_1 is the mean radius $(2a+b)/3$, R_2 the radius of a sphere having the same surface area as the ellipsoid, and R_3 is the radius of a sphere having the same volume as the ellipsoid. The derivation of the equations for these quantities will be discussed in later sections.

3.2 Geodetic Coordinates

We first consider a rotational ellipsoid whose center is at O . We define the OZ axis to be the rotational axis of the ellipsoid. The OX axis lies in the equatorial plane and intersects the meridian PEP_1 which is taken as the prime or initial meridian from which longitudes

will be measured. The OY axis is in the equatorial plane, perpendicular to the OX axis such that OX, OY, OZ form a right handed coordinate system as seen in Figure 3.3:

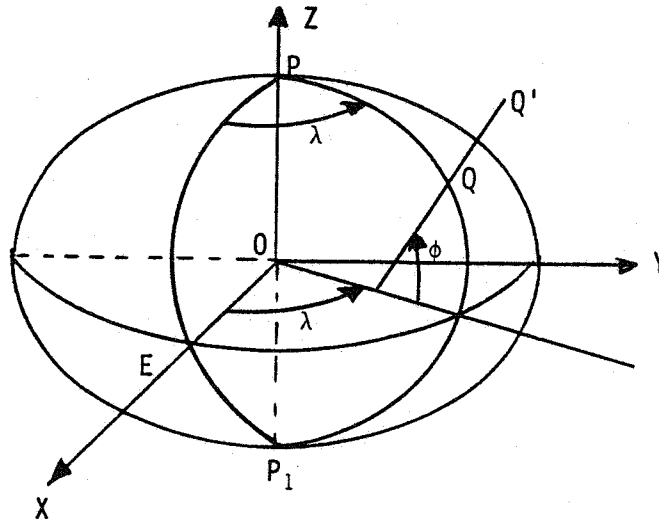

Figure 3.3
Coordinate Systems for the Ellipsoid

An arbitrary point Q or Q' (on or off the surface of the ellipsoid) may then be defined by its X, Y, Z coordinates.

We should note that on a given meridian such as PQP_1 or PEP_1 , the longitude is a constant, for any point located on this meridian plane. The geodetic longitude of a point is defined to be the dihedral angle between the planes of the prime meridian (PEP_1) and a meridian (e.g. PQP_1) passing through a given point. Longitudes in this book and for most cases are measured positive eastwards, although there are some cases (e.g. in the United States) where some references consider longitudes measured positive westward.

The geodetic latitude, ϕ , of a point located on the surface of the ellipsoid is defined as the angle between the normal to the ellipsoid at the point and the equatorial plane. For a point located above the surface of the ellipsoid, there are a number of different definitions possible. The simplest one is that it is the angle between the normal to the ellipsoid, passing through this point, and the equatorial plane. This system of coordinates (i.e. ϕ, λ) are called geodetic coordinates. (In some books some references may be found to geographic coordinates which are the same as geodetic coordinates). ϕ and λ form a set of curvilinear coordinates on the surface of the ellipsoid. They allow the description of many properties involved with the surface and curves on the surface.

3.3 The Meridian Ellipse

The meridian ellipse passing through point Q is shown in Figure 3.4 with coordinates axes z and x .

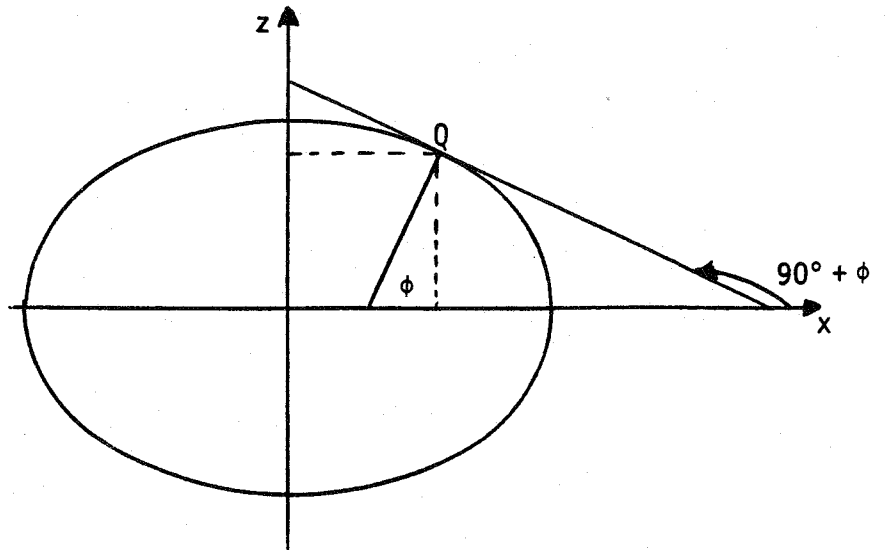

Figure 3.4
The Meridian Ellipse

In addition to geodetic latitude we may also define the reduced latitude β and the geocentric latitude ψ . The reduced latitude (sometimes called the parametric latitude) is the angle at the center of a sphere that is tangent to the ellipsoid along the equator, between the plane of the equator and the radius to the point intersected along the sphere by a straight line perpendicular to the plane of the equator and passing through the point on the ellipsoid whose reduced latitude is being defined. The reduced latitude is shown in Figure 3.5.

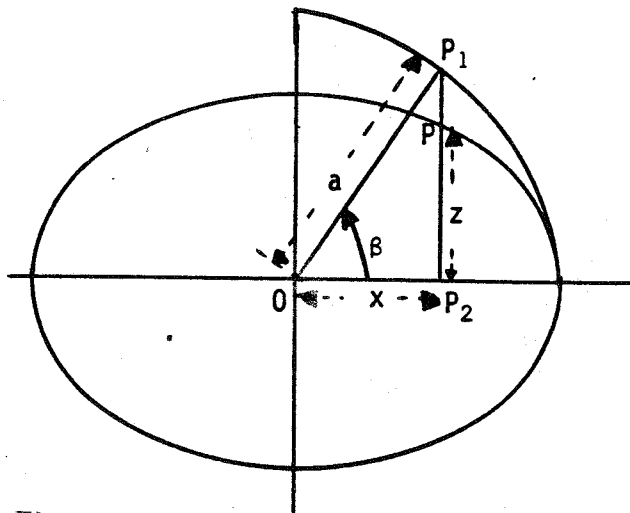

Figure 3.5
The Reduced Latitude

The geocentric latitude is the angle at the center of the ellipse between the plane of the equator and a line to the point whose geocentric latitude is being defined. Note that this definition allows a simple means to define this latitude even though the point may not be located on the surface of the ellipsoid. The geocentric latitude is shown in Figure 3.6.

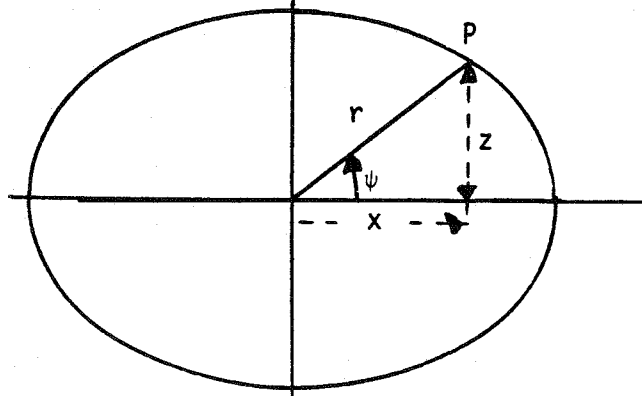

Figure 3.6
The Geocentric Latitude

The z and x coordinates may be computed knowing either ϕ , β , or ψ and the parameters of the ellipsoid. These relationships are useful in deriving expressions that relate the various latitudes.

We first consider the determination of x and z using the reduced latitude β . From Figure 3.5 we write:

$$(OP_2)^2 + (P_2 P_1)^2 = a^2 \quad (3.22)$$

The equation of this ellipse may be written:

$$\frac{x^2}{a^2} + \frac{z^2}{b^2} = 1 \quad (3.23)$$

or with $x = OP_2$ and $z = P_2 P$ we have:

$$\frac{(OP_2)^2}{a^2} + \frac{(P_2 P)^2}{b^2} = 1 \quad (3.24)$$

Combining (3.22) and (3.24) we have:

$$(OP_2)^2 + (P_2 P)^2 \frac{a^2}{b^2} = a^2 = (OP_2)^2 + (P_2 P_1)^2 \quad (3.25)$$

Solving for P_2P we find:

$$P_2P = \frac{b}{a} P_2P_1 \quad (3.26)$$

We have from Figure 3.5 that:

$$P_2P_1 = a \sin \beta \quad (3.27)$$

so that the x and z coordinates are:

$$x = OP_2 = a \cos \beta \quad (3.28)$$

$$z = P_2P = b \sin \beta \quad (3.29)$$

To determine x and z using geodetic latitude we note, considering Figure 3.4 that the slope of the tangent line is the tangent of the angle with the positive axis;

$$\frac{dz}{dx} = \tan (90 + \phi) = -\cot \phi = \frac{-\cos \phi}{\sin \phi} \quad (3.30)$$

where $\frac{dz}{dx}$ is the slope of the tangent line. To determine the derivative we rewrite equation (3.23) as follows:

$$b^2x^2 + a^2z^2 = a^2b^2 \quad (3.31)$$

and differentiate to get

$$b^2x dx + a^2z dz = 0 \quad (3.32)$$

or rearranging we have:

$$\frac{dz}{dx} = \frac{-b^2}{a^2} \cdot \frac{x}{z} = \frac{-\cos \phi}{\sin \phi} \quad (3.33)$$

Using equation (3.26) and (3.33) we have:

$$b^2 x \sin \phi = a^2 z \cos \phi \quad (3.34)$$

Squaring both sides we have:

$$b^4 x^2 \sin^2 \phi - a^4 z^2 \cos^2 \phi = 0 \quad (3.35)$$

We then multiply equation (3.31) by $-b^2 \sin^2 \phi$, add the result to equation (3.35) and multiply through by -1 , and then solve for z to find:

$$z = \frac{b^2 \sin \phi}{(a^2 \cos^2 \phi + b^2 \sin^2 \phi)^{\frac{1}{2}}} \quad (3.36)$$

In a similar elimination procedure we find for x :

$$x = \frac{a^2 \cos \phi}{(a^2 \cos^2 \phi + b^2 \sin^2 \phi)^{\frac{1}{2}}} \quad (3.37)$$

Using e^2 from equation (3.4) the denominators of equation (3.36) and (3.37) become $a(1-e^2 \sin^2 \phi)^{\frac{1}{2}}$ so that x and z may be written:

$$x = \frac{a \cos \phi}{(1-e^2 \sin^2 \phi)^{\frac{1}{2}}} \quad (3.38)$$

$$z = \frac{a(1-e^2) \sin \phi}{(1-e^2 \sin^2 \phi)^{\frac{1}{2}}} \quad (3.39)$$

At this point it is convenient to introduce and define four new quantities:

$$\begin{aligned} W^2 &\equiv 1 - e^2 \sin^2 \phi \\ V^2 &\equiv 1 + e'^2 \cos^2 \phi \\ w^2 &\equiv 1 - e^2 \cos^2 \beta \\ v^2 &\equiv 1 + e'^2 \sin^2 \beta \end{aligned} \quad (3.40)$$

Starting from these designations, various other relations may be derived.

$$W^2 = \frac{1}{1+e'^2 \sin^2 \beta} \quad (3.41)$$

$$V^2 = \frac{1}{1-e^2 \cos^2 \beta}$$

Using W and V in equations (3.38) and (3.39) we can write:

$$x = \frac{a \cos \phi}{W} \quad (3.42)$$

$$z = \frac{a(1-e^2) \sin \phi}{W} \quad (3.43)$$

$$x = \frac{c}{V} \cos \phi \quad (3.44)$$

$$z = \frac{c}{V} \frac{\sin \phi}{(1+e'^2)} \quad (3.45)$$

where $c = a^2/b$. A geometric interpretation for c will be given later.

A geometric meaning may be attached to W and V by considering elements in Figure 3.7.

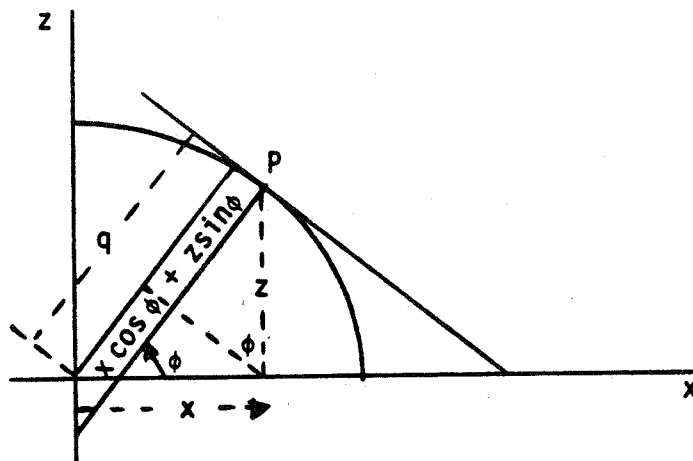

Figure 3.7
A Geometric Interpretation to W and V

In this figure q is a distance measured from the origin to the plane at P (whose geodetic latitude is ϕ) such that the line from the origin is perpendicular to the tangent plane. We have:

$$q = x \cos \phi + z \sin \phi \quad (3.46)$$

Substituting from equations (3.42) and (3.43) we have:

$$q = aW \quad (3.47)$$

From (3.44) and (3.45) we have:

$$q = bV \quad (3.48)$$

We can equate (3.47) and (3.48) to finally write:

$$W = \frac{b}{a} V \quad (3.49)$$

We next turn to the determination of x and z using the geocentric latitude. From Figure 3.6 we write:

$$x = r \cos \psi \quad (3.50)$$

$$z = r \sin \psi \quad (3.51)$$

where r is the geocentric radius.

Clearly we have:

$$r = \sqrt{x^2 + z^2} \quad (3.52)$$

Substituting equation (3.50) and (3.51) into equation (3.23), and solving for r we find:

$$r = \frac{a(1-e^2)^{\frac{1}{2}}}{\sqrt{1-e^2 \cos^2 \psi}} = \frac{b}{\sqrt{1-e^2 \cos^2 \psi}} \quad (3.53)$$

Substituting this value of r back into equations (3.50) and (3.51) we have:

$$x = \frac{a(1-e^2)^{\frac{1}{2}} \cos \psi}{\sqrt{1-e^2 \cos^2 \psi}} \quad (3.54)$$

$$z = \frac{a(1-e^2)^{\frac{1}{2}} \sin \psi}{\sqrt{1-e^2 \cos^2 \psi}} \quad (3.55)$$

We could also obtain expression for the radius vector in terms of geodetic latitude if we substitute equations (3.38) and (3.39) into equation (3.52). We find:

$$r = \frac{a}{W} (1 + e^2 (e^2 - 2) \sin^2 \phi)^{\frac{1}{2}} \quad (3.56)$$

Since the second term on the right hand side of (3.56) is on the order of e^2 it is convenient to obtain a series expression for the radius vector. We first expand the square root term using the binomial series (equation (2.7)) so that:

$$r = \frac{a}{W} (1 + \frac{1}{2} e^2 (e^2 - 2) \sin^2 \phi - \frac{1}{2} e^4 \sin^4 \phi + \dots) \quad (3.57)$$

Now compute a Maclaurin series expansion (equation (2.4)) for $1/W$:

$$\frac{1}{W} = 1 + \frac{e^2}{2} \sin^2 \phi + \frac{3}{8} e^4 \sin^4 \phi + \dots \quad (3.58)$$

Multiplying (3.57) and (3.58) we find a series expression for r in terms of geodetic latitude:

$$r = a(1 - \frac{e^2}{2} \sin^2 \phi + \frac{e^4}{2} \sin^2 \phi - \frac{5}{8} e^4 \sin^4 \phi + \frac{3}{4} e^6 \sin^4 \phi - \frac{13}{16} e^6 \sin^6 \phi + \dots) \quad (3.59)$$

The number of terms to retain in such an expression depends on the accuracy desired. Recalling that for the Geodetic Reference System 1980, $a = 6378137$ m, $e^2 = 0.00669\dots$ the last two terms in equation (3.59) have a maximum value of 0.0008 meters.

3.4 Relationships Between the Various Latitudes

We may use some of the equations previously derived to obtain relationships between the various latitudes described. From Figure 3.6 we write:

$$\tan \psi = \frac{z}{x} \quad (3.60)$$

Substituting for z and x from equations (3.28), (3.29) and (3.38), (3.39) we have:

$$\tan \psi = \frac{b}{a} \tan \beta = (1 - e^2) \tan \phi \quad (3.61)$$

Thus we have:

$$\tan \psi = (1 - e^2)^{\frac{1}{2}} \tan \beta = (1 - e^2) \tan \phi \quad (3.62)$$

$$\tan \beta = (1 - e^2)^{\frac{1}{2}} \tan \phi \quad (3.63)$$

$$\tan \phi = (1 + e'^2)^{\frac{1}{2}} \tan \beta \quad (3.64)$$

Although these relationships are sufficient to determine one type of latitude given any other, certain procedures are simplified if other relationships are also found. For example, we equate the z coordinate as given in equations (3.29) and (3.43) to obtain:

$$\sin \beta = \frac{(1 - e^2)^{\frac{1}{2}} \sin \phi}{W} = \frac{\sin \phi}{V} \quad (3.65)$$

Equating equations (3.28) and (3.42) dealing with the x coordinate we have

$$\cos \beta = \frac{\cos \phi}{W} \quad (3.66)$$

Other relations of interest include the following:

$$\cos \phi = \frac{\cos \beta}{V} = (1 - e^2)^{\frac{1}{2}} \frac{\cos \beta}{W} \quad (3.67)$$

$$\sin \phi = \frac{\sin \beta}{W} = (1 + e'^2)^{\frac{1}{2}} \frac{\sin \beta}{V} \quad (3.68)$$

Next we turn to the determination of expressions for the determination of the difference between two types of latitude. We first consider closed expressions and then series expressions. We now consider the difference between the geodetic and reduced latitude by writing:

$$\sin (\phi - \beta) = \sin \phi \cos \beta - \cos \phi \sin \beta \quad (3.69)$$

We then substitute values of $\sin \beta$ and $\cos \beta$ from equations (3.65) and (3.66) to obtain after some reductions:

$$\sin (\phi - \beta) = \frac{f \sin 2\phi}{2W} \quad (3.71)$$

Another closed expression may be written starting from the following identity:

$$\tan (\phi - \beta) = \frac{\tan \phi - \tan \beta}{1 + \tan \phi \cdot \tan \beta} \quad (3.72)$$

Substituting for $\tan \beta$ as a function of $\tan \phi$ we find:

$$\tan (\phi - \beta) = \frac{n \sin 2\phi}{1 + n \cos 2\phi} \quad (3.73)$$

Closed expressions giving a function of $(\phi - \psi)$ as a function of either ϕ or ψ can be derived in closed or series form. To derive a closed expression we write:

$$\tan (\phi - \psi) = \frac{\tan \phi - \tan \psi}{1 + \tan \phi \cdot \tan \psi} \quad (3.74)$$

Substituting (3.61) for $\tan \psi$ we can write:

$$\tan (\phi - \psi) = \frac{e^2 \sin 2\phi}{2(1 - e^2 \sin^2 \phi)} \quad (3.75)$$

The derivation of series expressions for the differences of two latitudes can be done using equations (2.11) and (2.12). For example, we may apply this technique to equation (3.63) where $y = \beta$, $p = (1 - e^2)^{1/2}$ and $x = \phi$. We find:

$$\phi - \beta = n \sin 2\phi - \frac{n^2}{2} \sin 4\phi + \frac{n^3}{3} \sin 6\phi + \dots \quad (3.76)$$

This difference, as a function of β , may be written:

$$\phi - \beta = n \sin 2\beta + \frac{n^2}{2} \sin 4\beta + \frac{n^3}{3} \sin 6\beta + \dots \quad (3.77)$$

Using a similar approach the difference between the geodetic and geocentric latitude as a function of ϕ may be written:

$$\phi - \psi = m \sin 2\phi - \frac{m^2}{2} \sin 4\phi + \frac{m^3}{3} \sin 6\phi + \dots \quad (3.78)$$

This difference as a function of ψ is:

$$\phi - \psi = m \sin 2\psi + \frac{m^2}{2} \sin 4\psi + \frac{m^3}{3} \sin 6\psi + \dots \quad (3.79)$$

For the Clarke 1866 ellipsoid ($f = 1/294.978698$) we have (Adams, 1949):

$$\phi - \beta = 350''2202 \sin 2\phi - 0''2973 \sin 4\phi + 0''0003 \sin 6\phi + \dots \quad (3.80)$$

$$\phi - \psi = 700''4385 \sin 2\phi - 1''1893 \sin 4\phi + 0''0027 \sin 6\phi + \dots$$

For the ellipsoid of the Geodetic Reference system 1980 we have:

$$\phi - \beta = 346''3640 \sin 2\phi - 0''2908 \sin 4\phi + 0''0003 \sin 6\phi \quad (3.81)$$

$$\phi - \psi = 692''7262 \sin 2\phi - 1''1632 \sin 4\phi + 0''0026 \sin 6\phi$$

We can see that the maximum difference of $\phi - \beta$ is approximately 6' while the maximum difference of $\phi - \psi$ is 12'. This difference occurs close to latitude 45°.

3.5 Radii of Curvature on the Ellipsoid

Consider first a normal to the surface of the ellipsoid at some point. Now take a plane that contains this normal and thus is perpendicular to the tangent plane. This particular plane will cut the surface of the ellipsoid forming a curve which is known as a normal section. The radii of curvature of a normal section will depend on the azimuth of the line. At each point there exist two mutually perpendicular normal sections whose curvatures are maximum and minimum. Such normal sections are called principal normal sections.

On the ellipsoid these two normal sections are:

1. the meridional section, a plane passing through the given point and the two poles;
2. the prime vertical section, which is a section through the point and perpendicular to the meridional section at the point.

The radius of curvature in the meridian is designated M and the radius of curvature in the prime vertical direction is designated N .

In order to find the radius of curvature in an arbitrary direction we may utilize Euler's formula:

$$\frac{1}{\rho} = \frac{\cos^2\theta}{\rho_1} + \frac{\sin^2\theta}{\rho_2} \quad (3.82)$$

where ρ is the arbitrary radius of curvature;

θ is the angle measured from the principal section with the largest radius of curvature ρ_1 in a principle normal direction; and

ρ_2 is the radius of curvature in the direction of the other principal normal direction

After examining the N and M values we shall apply equation (3.82) to the ellipsoid case.

3.51 The Radius of Curvature in the Meridian

We first consider the determination of M. We first recall that if we have a plane curve specified as $z = F(x)$, the radius of curvature at a point on the curve is:

$$\rho = \frac{[1 + (\frac{dz}{dx})^2]^{3/2}}{\frac{d^2z}{dx^2}} \quad (3.83)$$

From equation (3.30) we have:

$$\frac{dz}{dx} = -\cot \phi$$

Then we differentiate this:

$$\frac{d^2z}{dx^2} = \frac{1}{\sin^2\phi} \frac{d\phi}{dx} = \frac{1}{\sin^2\phi} \frac{1}{\frac{dx}{d\phi}} \quad (3.84)$$

From equation (3.38) we have:

$$x = \frac{a \cos \phi}{(1-e^2 \sin^2 \phi)^{1/2}}$$

which is differentiated with respect to ϕ to obtain:

$$\frac{dx}{d\phi} = \frac{-a(1-e^2)\sin \phi}{(1-e^2 \sin^2 \phi)^{3/2}} \quad (3.85)$$

Using (3.85) in (3.84) we have:

$$\frac{d^2z}{dx^2} = \frac{-(1-e^2 \sin^2 \phi)^{3/2}}{a \sin^3 \phi (1-e^2)} \quad (3.86)$$

Substituting the values of (3.86) and of dz/dx into (3.82) when ρ is now M we find:

$$M = \frac{a(1-e^2)}{(1-e^2 \sin^2 \phi)^{3/2}} \quad (3.87)$$

where the minus sign has been dropped by convention. Recalling the definitions of W , V , and c , alternate expressions for M are:

$$M = \frac{a(1-e^2)}{W^3} = \frac{c}{V^3} \quad (3.88)$$

We now consider an alternate derivation for M considering Figure 3.8:

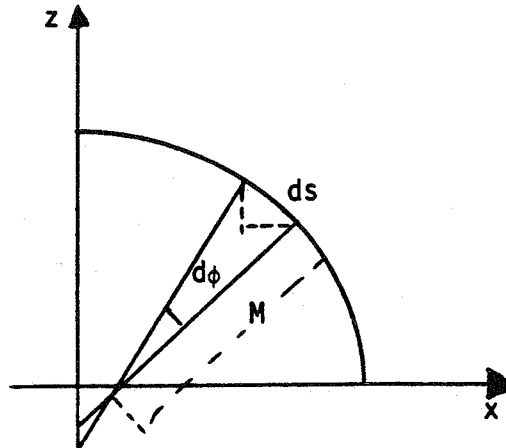

Figure 3.8
A Portion of a Meridian Arc

We have ds a differential distance along a meridian arc; $d\phi$ is the angular separation. Then we regard M as the radius of curvature of the meridian arc so that:

$$\begin{aligned} ds = M d\phi &= \sqrt{dx^2 + dz^2} = dz \sqrt{1 + \left(\frac{dx}{dz}\right)^2} \\ &= dz \sqrt{1 + \tan^2 \phi} = \frac{dz}{\cos \phi} \end{aligned} \quad (3.89)$$

since:

$$\frac{dz}{dx} = -\cot \phi \quad \text{from equation (3.30)}$$

Then:

$$\begin{aligned} M d\phi &= \frac{dz}{\cos \phi} \quad \text{or} \\ M &= \frac{1}{\cos \phi} \frac{dz}{d\phi} \end{aligned} \quad (3.90)$$

Using equation (3.39) for z we find:

$$\frac{dz}{d\phi} = \frac{a(1-e^2)\cos \phi}{W^3} \quad (3.91)$$

which yields from (3.90)

$$M = \frac{a(1-e^2)}{W^3}$$

which is the same as (3.88)

At the equator $\phi = 0$ so that:

$$M_{\phi=0} = a(1-e^2) = a(1-f)^2 \quad (3.92)$$

At the poles $\phi = \pm 90^\circ$ so that:

$$M_{\phi=90^\circ} = \frac{a(1-e^2)}{(1-e^2)^{3/2}} = \frac{a}{(1-e^2)^{1/2}} = \frac{a}{1-f} = \frac{a^2}{b} = c \quad (3.93)$$

In this expression, c , as introduced earlier, is seen to be the radius of curvature at the pole.

We could take the ratio:

$$\frac{M_{90}}{M_0} = \frac{a}{1-f} \cdot \frac{1}{a(1-f)^2} = \frac{1}{(1-f)^3}$$

or

$$M_{90} = \frac{M_0}{(1-f)^3} \quad (3.94)$$

If values of M were tabulated, they could be plotted with respect to an origin at the surface of the reference ellipsoid. The end point of the various M values would fall on a curve as shown in the following diagram.

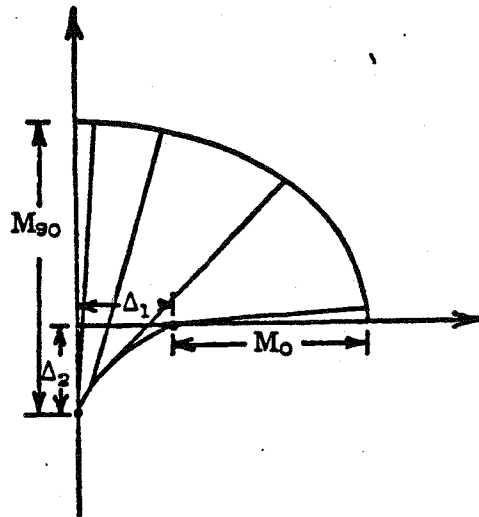

Figure 3.9
Equatorial and Polar Meridian Radii of Curvature

Let us define Δ_1 and Δ_2 as shown in the diagram:

Then:

$$\Delta_1 = a - a(1-f)^2 = a(2f-f^2) = ae^2$$

$$\Delta_1 = ae^2 \quad (3.95)$$

In addition:

$$\Delta_2 = \frac{a}{1-f} - b = \frac{a(2f-f^2)}{(1-f)}$$

$$\Delta_2 = \frac{ae^2}{(1-f)} = \frac{\Delta_1}{(1-f)} \quad (3.96)$$

For the Geodetic Reference System 1980 we have the following values for Δ_1 and Δ_2 .

$$\Delta_1 = 42,697.67 \text{ m}$$

$$\Delta_2 = 42,841.31 \text{ m}$$

3.52 Radius of Curvature in the Prime Vertical

There are several procedures to derive N . One approach is to use the theorem of Meisner that the radius of the curvature of an inclined section is equal to the curvature radius of a normal section multiplied by the cosine of the angle between these sections. In our case we want to find the radius of curvature of the normal section knowing the radius of curvature of the inclined section. We have:

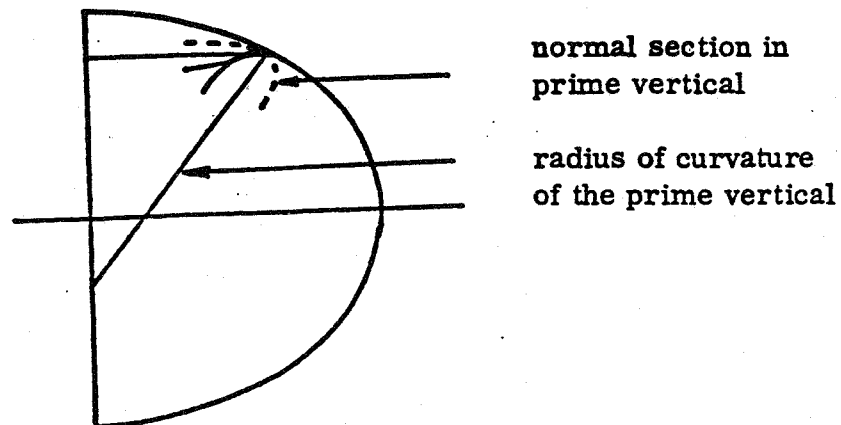

Figure 3.10
Prime Vertical Radius of Curvature

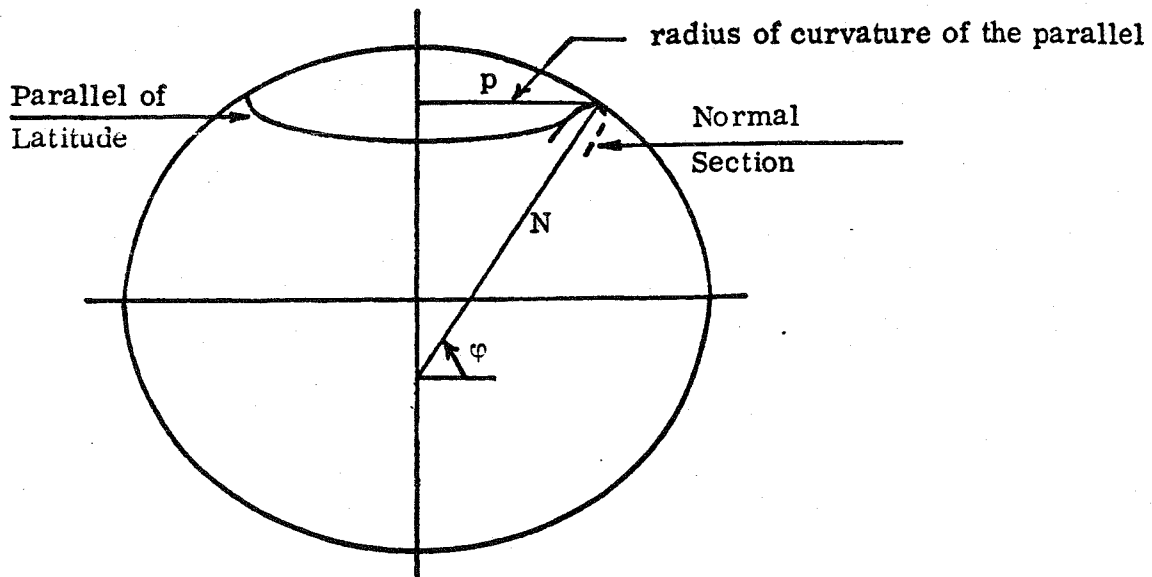

Figure 3.11
Geometry for the Use of Meusnier's Theorem

In the above figure N is the length of the normal line from the surface of the ellipsoid to the intersection of this line with the minor axis.

The radius of curvature of the parallel is p . From the figure:

$$p = N \sin (90 - \phi) = N \cos \phi \quad (3.97)$$

The angle between the prime vertical section and the inclined section is ϕ . Then:

$$p = (\text{prime vertical radius of curvature}) \times \cos \phi \quad (3.98)$$

In equations (3.97) and (3.98) we see that the radius of curvature in the prime vertical direction is N .

An alternate approach is from a geometric argument. To do this we consider the following figure where a prime vertical section has been drawn.

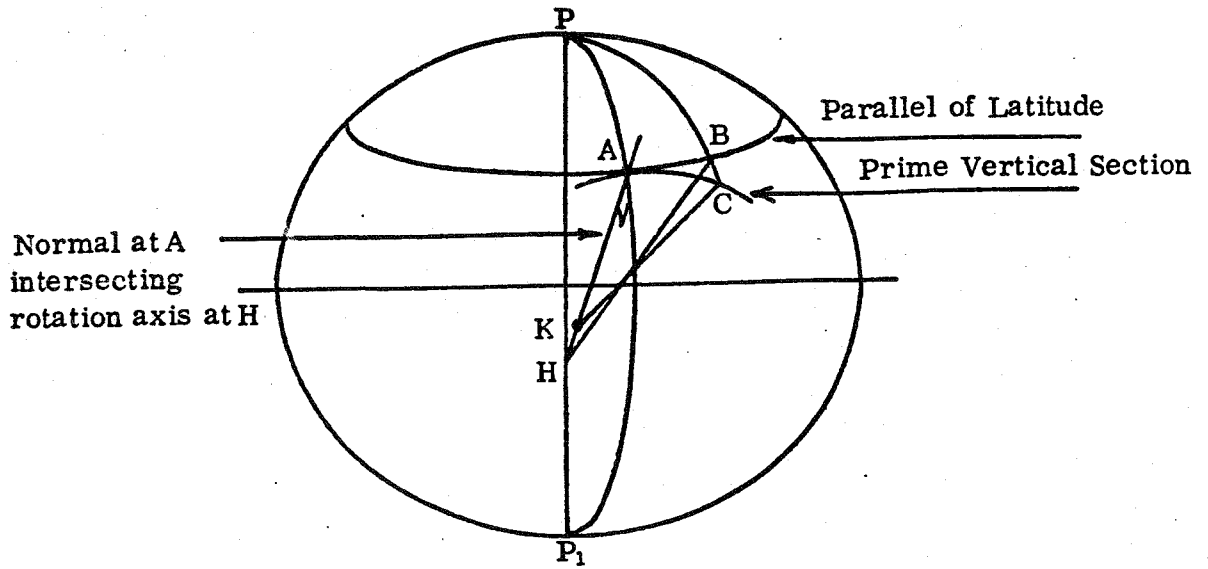

Figure 3.12
Geometric Derivation for $N(A)$

In this figure, PAP_1 represents the meridian through A . AH is the normal at A , intersecting the rotation axis. B is an arbitrary point on the same parallel as A , while BH is the normal at B intersecting the rotation axis at H . C is a point on the prime vertical section through A and that also lies on the meridian passing through B .

We construct a normal at C that will intersect (at K) the normal from A since AC is a plane curve. We can say that K is the approximate center of curvature of the arc AC . Now let the point B approach point A , so that C will approach A . The intersection of the normals will approach the true center of curvature and CK will approach the true radius of curvature of the arc. Now as C approaches A , C also approaches B so that K will approach H . Thus the radius of curvature of the prime vertical section at A must be the distance from H to A or AH . To compute this radius we consider the meridian ellipse in the following figure.

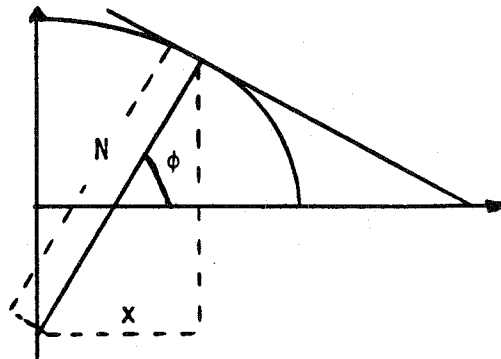

Figure 3.13
Geometric Derivation of $N(B)$

From the figure we have:

$$x = N \cos \phi$$

Using the expression for x derived previously we can solve for N to find:

$$N = \frac{a}{(1 - e^2 \sin^2 \phi)^{1/2}} = \frac{a}{W} = \frac{c}{V} \quad (3.99)$$

At the equator the prime vertical radius of curvature is:

$$N_{\phi=0} = a \quad (3.100)$$

At the pole:

$$N_{\phi=90^\circ} = \frac{a}{1 - f} = \frac{a^2}{b} \quad (3.101)$$

We thus see that M (see 3.92 and 3.39) and N are a minimum for points on the equator. At the pole $M = N = a^2/b = c$ so that both curvatures are the same.

We may find the ratio of N/M by using equations (3.88) and (3.99). We have:

$$\frac{N}{M} = \frac{c}{V} \cdot \frac{V^3}{c} = V^2$$

or:

$$\frac{N}{M} = V^2 = 1 + e'^2 \cos^2 \phi \quad (3.102)$$

Thus $N \geq M$ where the equality holds at the pole.

3.53 The Radius of Curvature in the Normal Section Azimuth α

Since N is generally greater than M , we associate N with ρ_1 that arose in equation (3.82). If we let α be the azimuth of a line for which we are interested in the curvature, we have $\theta = 90^\circ - \alpha$. If $\rho = R_\alpha$ we then may express equation (3.82) in the following form for the ellipsoid of revolution.

$$\frac{1}{R_\alpha} = \frac{\sin^2 \alpha}{N} + \frac{\cos^2 \alpha}{M} \quad (3.103)$$

or:

$$R_\alpha = \frac{MN}{N \cos^2 \alpha + M \sin^2 \alpha} = \frac{N}{1 + e'^2 \cos^2 \alpha \cos^2 \phi} \quad (3.104)$$

3.6 Meridian Arc Lengths

We next turn to the computation of lengths of meridian arcs. A differential arc length was written in equation (3.89) as:

$$ds = M d\phi$$

In order to find the length of arc between two points with latitudes ϕ_1 and ϕ_2 we integrate the above equation to write:

$$s = \int_{\phi_1}^{\phi_2} M d\phi = a(1-e^2) \int_{\phi_1}^{\phi_2} \frac{d\phi}{W^3} \quad (3.105)$$

The integral

$$\int \frac{d\phi}{W^3} = \int (1-e^2 \sin^2 \phi)^{-3/2} d\phi$$

represents an elliptical integral which can not be integrated in elementary functions. Instead the value of $1/W^3$ is expanded in a series and the integration is carried out term by term. First we find the Maclaurin series expansion of $1/W^3$ to be:

$$\frac{1}{W^3} = 1 + \frac{3}{2} e^2 \sin^2 \phi + \frac{15}{8} e^4 \sin^4 \phi + \frac{35}{16} e^6 \sin^6 \phi + \frac{315}{128} e^8 \sin^8 \phi + \frac{693}{256} e^{10} \sin^{10} \phi \dots \quad (3.106)$$

For ease in integration we replace the powers of $\sin \phi$ by multiple angle equivalents as given in equation (2.18) to find:

$$\frac{1}{W^3} = A - B\cos 2\phi + C\cos 4\phi - D\cos 6\phi + E\cos 8\phi - F\cos 10\phi + \dots \quad (3.107)$$

where the coefficients A, B, etc. have the following meaning:

$$\begin{aligned} A &= 1 + \frac{3}{4}e^2 + \frac{45}{64}e^4 + \frac{175}{256}e^6 + \frac{11025}{16384}e^8 + \frac{43659}{65536}e^{10} + \dots \\ B &= \frac{3}{4}e^2 + \frac{15}{16}e^4 + \frac{525}{512}e^6 + \frac{2205}{2048}e^8 + \frac{72765}{65536}e^{10} + \dots \\ C &= \frac{15}{64}e^4 + \frac{105}{256}e^6 + \frac{2205}{4096}e^8 + \frac{10395}{16384}e^{10} + \dots \\ D &= \frac{35}{512}e^6 + \frac{315}{2048}e^8 + \frac{31185}{131072}e^{10} + \dots \\ E &= \frac{315}{16384}e^8 + \frac{3465}{65536}e^{10} + \dots \\ F &= \frac{693}{131072}e^{10} + \dots \end{aligned} \quad (3.108)$$

We can now substitute (3.107) into (3.105) to write:

$$\begin{aligned} s &= a(1-e^2) \int_{\phi_1}^{\phi_2} (A - B\cos 2\phi + C\cos 4\phi) d\phi + \dots \\ &= a(1-e^2) \left[\int_{\phi_1}^{\phi_2} A d\phi - B \int_{\phi_1}^{\phi_2} \cos 2\phi d\phi + C \int_{\phi_1}^{\phi_2} \cos 4\phi d\phi \right] + \dots \\ &= a(1-e^2) \left[A\phi \Big|_{\phi_1}^{\phi_2} - \frac{B}{2} \sin 2\phi \Big|_{\phi_1}^{\phi_2} + \frac{C}{4} \sin 4\phi \Big|_{\phi_1}^{\phi_2} \right] + \dots \quad (3.109) \\ s &= a(1-e^2) \left[A(\phi_2 - \phi_1) - \frac{B}{2} (\sin 2\phi_2 - \sin 2\phi_1) + \frac{C}{4} (\sin 4\phi_2 - \sin 4\phi_1) \right. \\ &\quad \left. - \frac{D}{6} (\sin 6\phi_2 - \sin 6\phi_1) + \frac{E}{8} (\sin 8\phi_2 - \sin 8\phi_1) - \frac{F}{10} (\sin 10\phi_2 - \sin 10\phi_1) \right] + \dots \end{aligned} \quad (3.110)$$

This equation may be written in an alternate form by using equation (2.22)

In this case $X = \phi_2$, $Y = \phi_1$, so that:

$$\sin n\phi_2 - \sin n\phi_1 = 2 \cos n \left(\frac{\phi_1 + \phi_2}{2} \right) \sin \frac{n}{2} (\phi_2 - \phi_1) \quad (3.111)$$

Letting:

$$\phi_m = \frac{\phi_1 + \phi_2}{2}$$

and:

$$\Delta\phi = \phi_2 - \phi_1$$

we can write specific values of (3.111) as:

$$\begin{aligned} \sin 2\phi_2 - \sin 2\phi_1 &= 2 \cos 2\phi_m \sin \Delta\phi \\ \sin 4\phi_2 - \sin 4\phi_1 &= 2 \cos 4\phi_m \sin 2\Delta\phi \\ \sin 6\phi_2 - \sin 6\phi_1 &= 2 \cos 6\phi_m \sin 3\Delta\phi \end{aligned} \quad (3.112)$$

and so forth. Equation (3.112) may then be substituted into equation (3.110) to yield:

$$\begin{aligned} s = a(1-e^2) & \left[A\Delta\phi - B \cos 2\phi_m \sin \Delta\phi + \frac{C}{2} \cos 4\phi_m \sin 2\Delta\phi - \frac{D}{3} \cos 6\phi_m \sin 3\Delta\phi \right. \\ & \left. + \frac{E}{4} \cos 8\phi_m \sin 4\Delta\phi - \frac{F}{5} \cos 10\phi_m \sin 5\Delta\phi + \dots \right] \end{aligned} \quad (3.113)$$

In order to compute the length of the meridian arc from the equator to an arbitrary latitude ϕ we let ϕ_1 equal zero and ϕ_2 equal ϕ in equation (3.110). We then find (with $s = S_\phi$):

$$S_\phi = a(1-e^2) \left[A\phi - \frac{B}{2} \sin 2\phi + \frac{C}{4} \sin 4\phi - \frac{D}{6} \sin 6\phi + \frac{E}{8} \sin 8\phi - \frac{F}{10} \sin 10\phi \right] + \dots \quad (3.114)$$

Helmert (1880) carried out an alternate derivation for the meridian arc length in which the expansion parameter is n instead of e^2 . In this case a faster convergence of the series is obtained. We have:

$$S_{\phi} = \frac{a}{1+n} [a_0 \phi - a_2 \sin 2\phi + a_4 \sin 4\phi - a_6 \sin 6\phi + a_8 \sin 8\phi] \quad (3.115)$$

where:

$$\begin{aligned} a_0 &= 1 + \frac{n^2}{4} + \frac{n^4}{64} \\ a_2 &= \frac{3}{2} (n - \frac{n^3}{8}) \\ a_4 &= \frac{15}{16} (n^2 - \frac{n^4}{4}) \\ a_6 &= \frac{35}{48} n^3 \\ a_8 &= \frac{315}{512} n^4 \end{aligned} \quad (3.116)$$

To achieve an accuracy in S_{ϕ} of 0.1 mm from the equator to the pole, it is sufficient to set a_8 to zero, and neglect terms of n^4 in the a_i coefficients.

Using either equation (3.114) or equation (3.115) it is a simple matter to find the arc distance from the equator to the pole by letting $\phi = 90^\circ$. From equations (3.114) and (3.115) we have:

$$S_{\phi=90^\circ} = a(1-e^2) A \frac{\pi}{2} = \frac{aa_0}{1+n} \frac{\pi}{2} \quad (3.117)$$

For the Geodetic Reference System 1980 we have the following constants associated with the meridian arc computation:

$$\begin{aligned} A &= 1.00505250181 \\ B &= 0.00506310862 \\ C &= 0.00001062759 \\ D &= 0.00000002082 \\ E &= 0.00000000004 \\ F &= 0.00000000000 \\ a_0 &= 1.00000070495 \\ a_2 &= 0.00251882970 \\ a_4 &= 0.00000264354 \\ a_6 &= 0.00000000345 \\ a_8 &= 0.00000000000 \end{aligned} \quad (3.118)$$

The evaluation of (3.117) gives for the quadrant of the ellipsoid of GRS80: 10,001,965.7293 m.

For some applications it is convenient to modify equations such as (3.113) so that equations valid for shorter length lines may be obtained. We make, in (3.113), the following substitution:

$$\sin\Delta\phi = \Delta\phi - \frac{\Delta\phi^3}{6}$$

$$\sin 2\Delta\phi = 2\Delta\phi$$

Retaining basic terms to $\cos 4\phi_m \sin 2\Delta\phi$ but making approximations consistent with the length of lines that the expressions are to be valid for we find (Zakatov, 1962, p. 27):

$$s = a\Delta\phi \left[1 - \left(\frac{1}{4} + \frac{3}{4} \cos 2\phi_m \right) \epsilon^2 - \left(\frac{3}{64} + \frac{3}{16} \cos 2\phi_m - \frac{15}{64} \cos 4\phi_m \right) \epsilon^4 + \frac{1}{8} \epsilon^2 \Delta\phi^2 \cos 2\phi_m \right] \quad (3.119)$$

Equation (3.119) is accurate for lines with $\Delta\phi = 5^\circ$ (length = 556 km) to .03 m. If $\Delta\phi = 10^\circ$ (length = 1100 km) the error is .07 m.

For even shorter lines, simplified equations may be derived. If we let M_m be the meridian radius of curvature at the mean latitude (i.e. ϕ_m) of the line, it can be shown (Zakatov, p. 27) that:

$$s = M_m \Delta\phi \left[1 + \frac{1}{8} \epsilon^2 \Delta\phi^2 \cos 2\phi_m \right] \quad (3.120)$$

For $\Delta\phi = 5^\circ$ the error in this equation is 0.03 m. For lines less than 45 km in length, the term in brackets in equation (3.120) may be dropped so that for this shorter distance we have:

$$s = M_m \Delta\phi \quad (3.121)$$

3.7 Length of a Parallel Arc

We next turn to the computation of the length of arc on the ellipsoid between two points having longitudes λ_2 and λ_1 situated on the same parallel. The distance, L , desired is indicated in Figure 3.14.

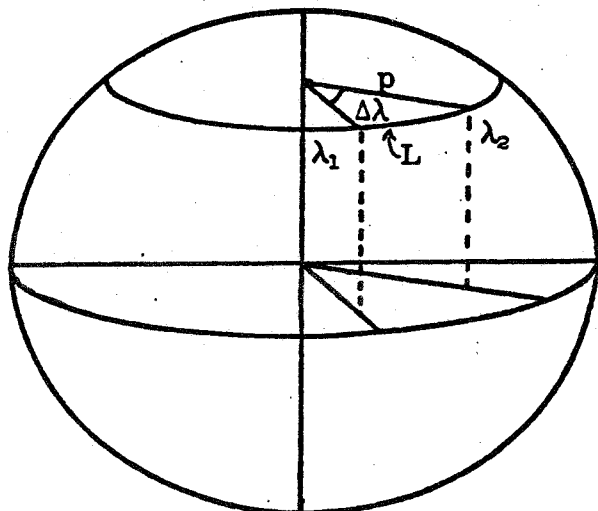

Figure 3.14
Parallel Arc Length

We recall from equation (3.97) that the length of the parallel radius p is $N \cos \phi$. Thus from the figure:

$$L = p \Delta \lambda = N \cos \phi \Delta \lambda \quad (3.122)$$

where $\Delta \lambda$ is in radians.

3.8 Calculation of Areas on the Surface of an Ellipsoid

We consider the area, on the ellipsoid, bounded by given meridians and parallels. To do this we first consider the differential figure shown in Figure 3.15.

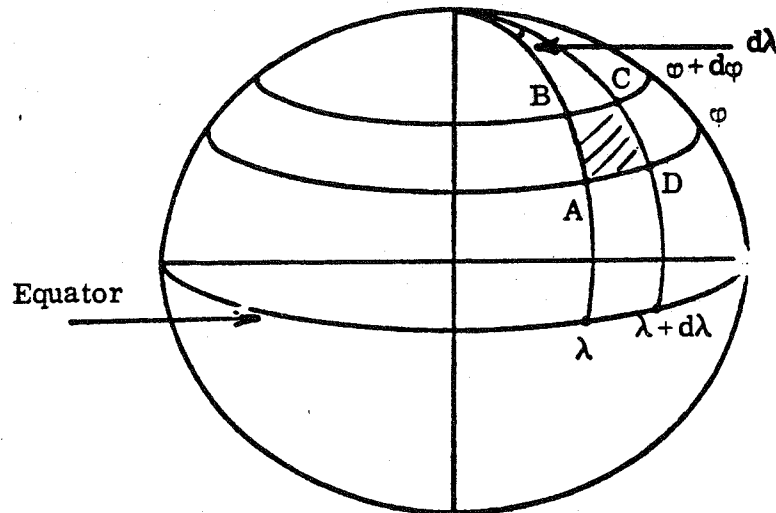

Figure 3.15
Area Element on the Ellipsoid

from the differential figure ABCD we have:

$$AB = CD = M d\phi \quad (3.123)$$

$$AD = BC = N \cos \phi d\lambda$$

Letting the area of the differential figure be dZ we have:

$$dZ = AD \cdot AB = MN \cos \phi d\phi d\lambda \quad (3.124)$$

The area between meridians designated by λ_2 and λ_1 , and parallels designated by ϕ_2 and ϕ_1 is:

$$Z = \int dz = \int_{\phi_1}^{\phi_2} \int_{\lambda_1}^{\lambda_2} MN \cos \phi d\phi d\lambda \quad (3.125)$$

Integrating with respect to λ we have:

$$Z = (\lambda_2 - \lambda_1) \int_{\phi_1}^{\phi_2} MN \cos \phi d\phi \quad (3.126)$$

In order to evaluate the integral we substitute for MN to write:

$$\int_{\phi_1}^{\phi_2} MN \cos \phi d\phi = b^2 \int_{\phi_1}^{\phi_2} \frac{\cos \phi}{(1 - e^2 \sin^2 \phi)^2} d\phi \quad (3.127)$$

The integral occurring in (3.127) may be given in closed form as follows (Bagratuni, 1967, p. 59):

$$b^2 \int_{\phi_1}^{\phi_2} \frac{\cos \phi d\phi}{(1 - e^2 \sin^2 \phi)^2} = \frac{b^2}{2} \left[\frac{\sin \phi}{1 - e^2 \sin^2 \phi} + \frac{1}{2e} \ln \frac{1 + e \sin \phi}{1 - e \sin \phi} \right] \Big|_{\phi_1}^{\phi_2} \quad (3.128)$$

Therefore equation (3.126) may be written:

$$Z = \frac{(\lambda_2 - \lambda_1) b^2}{2} \left[\frac{\sin \phi}{1 - e^2 \sin^2 \phi} + \frac{1}{2e} \ln \frac{1 + e \sin \phi}{1 - e \sin \phi} \right] \Big|_{\phi_1}^{\phi_2} \quad (3.129)$$

As a special case of equation (3.129) we compute the area on the ellipsoid from the equator to latitude ϕ , completely around the ellipsoid. Then $(\lambda_2 - \lambda_1) = 2\pi$, $\phi_1 = 0$ and $\phi_2 = \phi$ so that equation (3.129) becomes:

$$Z_{0-\phi} = \pi b^2 \left[\frac{\sin \phi}{1 - e^2 \sin^2 \phi} + \frac{1}{2e} \ln \frac{1 + e \sin \phi}{1 - e \sin \phi} \right] \quad (3.130)$$

If we are interested in the area of the half ellipsoid we let $\phi = 90^\circ$ in equation (3.130) to write:

$$Z_{0-90^\circ} = \pi b^2 \left[\frac{1}{1 - e^2} + \frac{1}{2e} \ln \frac{1 + e}{1 - e} \right] \quad (3.131)$$

In order to find the area of the whole ellipsoid multiply equation (3.131) by two.

In some cases, it may be more convenient to integrate equation (3.127) using an expansion of the kernel into a series and its subsequent term by term integration. We first write:

$$\frac{\cos \phi}{(1-e^2 \sin^2 \phi)^2} = \cos \phi + 2e^2 \cos \phi \sin^2 \phi + 3e^4 \cos \phi \sin^4 \phi + 4e^6 \cos \phi \sin^6 \phi + \dots \quad (3.132)$$

Equation (3.132) may be used in equation (3.127) which is used in (3.126) to find:

$$Z = b^2(\lambda_2 - \lambda_1) \left[\sin \phi + \frac{2}{3} e^2 \sin^3 \phi + \frac{3}{5} e^4 \sin^5 \phi + \frac{4}{7} e^6 \sin^7 \phi + \dots \right] \Big|_{\phi_1}^{\phi_2} \quad (3.133)$$

If $(\lambda_2 - \lambda_1) = 2\pi$, and $\phi_1 = 0^\circ$, we find an equation from (3.133) corresponding to (3.130) as:

$$Z_{0-\phi} = 2\pi b^2 \left[\sin \phi + \frac{2}{3} e^2 \sin^3 \phi + \frac{3}{5} e^4 \sin^5 \phi + \frac{4}{7} e^6 \sin^7 \phi + \frac{5}{9} e^8 \sin^9 \phi + \dots \right] \quad (3.134)$$

The area of the whole ellipsoid, Σ , may be found by letting $\phi = 90^\circ$ in equation (3.134) and doubling the result. We find:

$$\Sigma = 4\pi b^2 \left[1 + \frac{2}{3} e^2 + \frac{3}{5} e^4 + \frac{4}{7} e^6 + \frac{5}{9} e^8 + \frac{6}{11} e^{10} + \dots \right] \quad (3.135)$$

Equation (3.135) will be useful in a subsequent section

The area of the ellipsoid of GRS80 is 510065621.7 km².

3.9 Radii of Spherical Approximation to the Earth or Mean Radius of the Earth as a Sphere

In some applications it is convenient to let the earth be a sphere rather than an ellipsoid. It is then necessary to find a suitable radius, R , of the sphere to be used. A suitable radius may be defined in several ways that are outlined in the following sections.

3.91 The Gaussian Mean Radius

The Gaussian mean radius is defined to be the integral mean value of R taken over the azimuth varying from 0° to 360° . Designating such a radius as R we have:

$$R = \frac{1}{2\pi} \int_0^{2\pi} R_\alpha d\alpha = \frac{1}{2\pi} \int_0^{2\pi} \frac{MN}{N \cos^2 \alpha + M \sin^2 \alpha} d\alpha \quad (3.136)$$

$$R = \frac{2}{\pi} \int_0^{\frac{\pi}{2}} \frac{M}{\cos^2 \alpha \left(1 + \frac{M}{N} \tan^2 \alpha\right)} d\alpha \quad (3.137)$$

Removing \sqrt{MN} , equation (3.137) may be written as:

$$R = \frac{2}{\pi} \sqrt{MN} \int_0^{\frac{\pi}{2}} \frac{\frac{\sqrt{M}}{N} \frac{d\alpha}{\cos^2 \alpha}}{1 + \left(\frac{\sqrt{M}}{N} \tan \alpha\right)^2} \quad (3.138)$$

If we let $t = \sqrt{(M/N)} \tan \alpha$, and change the limits, equation (3.138) may be written as:

$$R = \frac{2}{\pi} \sqrt{MN} \int_0^{\infty} \frac{dt}{1+t^2} \quad (3.139)$$

which upon integration yields:

$$R = \sqrt{MN} = \frac{a\sqrt{1-e^2}}{1-e^2 \sin^2 \phi} \quad (3.140)$$

3.92 Radius of a Sphere Having the Mean of the Three Semi Axes of the Ellipsoid

We let:

$$R_m = \frac{a+a+b}{3} \quad (3.140)$$

Substituting for b and expanding we have:

$$R_m = a \left[\frac{2}{3} + \frac{\sqrt{1-e^2}}{3} \right] = a \left[\frac{2}{3} + \frac{1}{3} \left(1 - \frac{e^2}{2} + \dots \right) \right] \quad (3.141)$$

$$R_m = a \left(1 - \frac{e^2}{6} - \frac{e^4}{24} - \frac{e^6}{48} \dots \right)$$

3.93 Spherical Radius of Sphere Having the Same Area as the Ellipsoid

To find such a radius we set the area of a sphere equal to the area of the ellipsoid letting R_A be the radius of the sphere. Then:

$$4\pi R_A^2 = \Sigma \quad (3.142)$$

We find R_A from:

$$R_A = \sqrt{\frac{\Sigma}{4\pi}} \quad (3.143)$$

Using equation (3.135) we find:

$$R_A = a \left(1 - \frac{e^2}{6} - \frac{17}{360} e^4 - \frac{37}{3024} e^6 + \dots \right) \quad (3.144)$$

3.94 Radius of a Sphere having the Same Volume as the Ellipsoid

The volume of a sphere, V_S , is expressed as:

$$V_S = \frac{4}{3} \pi R_V^3 \quad (3.145)$$

where R_V is the radius of the sphere. The volume of an ellipsoid is expressed as:

$$V_E = \frac{4}{3} \pi a^2 b \quad (3.146)$$

Equating equation (3.145) and (3.146) we find:

$$R_V = \sqrt[3]{a^2 b} \quad (3.147)$$

Substituting for b we have:

$$R_V = a(1-e^2)^{1/6} \quad (3.148)$$

Expanding $(1-e^2)^{1/6}$ into a Maclaurin series, equation (3.148) can be expressed as:

$$R_V = a \left(1 - \frac{e^2}{6} - \frac{5}{72} e^4 - \frac{55}{1296} e^6 \dots \right) \quad (3.149)$$

For the parameters of the Geodetic Reference System 1980 we have:

$$R_m = 6371008.7714 \text{ m}$$

$$R_A = 6371007.1810 \text{ m}$$

$$R_V = 6371000.7900 \text{ m}$$

Clearly the distinction between these radii is numerically small. For most applications one might use simply 6371 km. An alternate technique for a spherical radius is to take the Gaussian mean radius at a specified latitude.

3.10 Space Rectangular Coordinates

In discussions connected with Figure 3.3 we defined the X, Y, Z axis. Now we consider the computation of the X, Y, Z coordinates of a point located at a geometric height, h , above the reference ellipsoid. The geometric height is measured along the ellipsoidal normal. To start we consider the meridian ellipse shown in Figure 3.16.

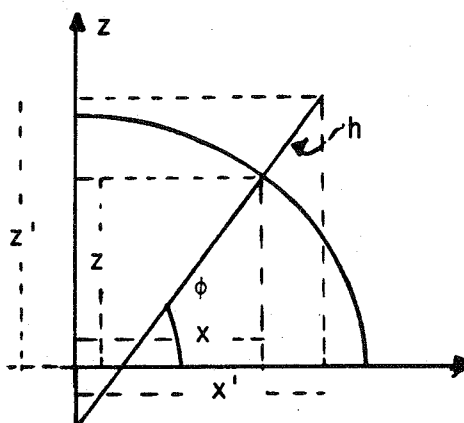

Figure 3.16
The Geometry of a Point Above a Meridian Ellipse

We have:

$$x' = x + h \cos \phi \tag{3.150}$$

$$z' = z + h \sin \phi$$

where x and z are given by equations (3.42) and (3.44).

The space rectangular coordinates, as can be seen from Figure 3.16 can be related to x' and z' as follows:

$$X = x' \cos \lambda$$

$$Y = x' \sin \lambda \tag{3.151}$$

$$Z = z'$$

Using equations (3.42) and (3.43) and the expression for x' and z' , we have:

$$\begin{aligned} X &= (N + h) \cos\phi \cos\lambda \\ Y &= (N + h) \cos\phi \sin\lambda \\ Z &= (N(1 - e^2) + h) \sin\phi \end{aligned} \tag{3.152}$$

where $N = a/W$. A problem to be discussed later will be the computation of ϕ , λ , and h given the space rectangular coordinates X , Y , Z .

3.11 An Alternate Form for the Equation of the Ellipsoid

We have previously written the equation of an ellipse (see equation 3.23) in the form:

$$\frac{x^2}{a^2} + \frac{z^2}{b^2} = 1$$

where x is the coordinate measured parallel to the semi-major axis and z is measured parallel to the semi-minor axis. The equation of the ellipsoid can be written in a similar fashion as:

$$\frac{X^2}{a^2} + \frac{Y^2}{a^2} + \frac{Z^2}{b^2} = 1 \tag{3.153}$$

where X , Y , Z are the space rectangular coordinates for the points on the ellipsoid.

An alternate form to (3.153) has been described by Tobey (1928). We first define the axes x' , y' , and z' at a point P on the surface of the ellipsoid. x' is tangent to the ellipsoid towards the pole, y' is tangent to the ellipsoid in an easterly direction and z' is normal to the ellipsoid, positive towards the center. This system is shown in Figure 3.17.

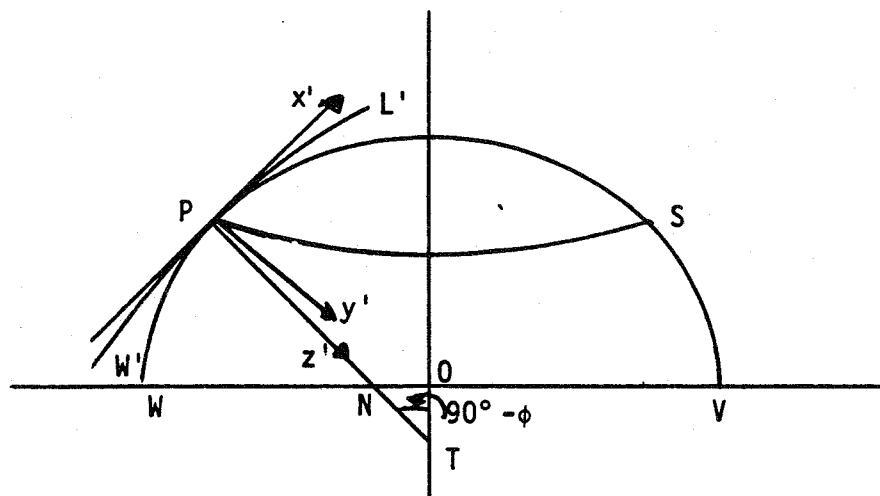

Figure 3.17
A Local Coordinate System on the Ellipsoid

Using the notation of Tobey we indicate the meridian section of the ellipse as WPLSV. The normal from P to the minor axis is the prime vertical radius of curvature, N, and ϕ is the geodetic latitude of point P.

Define a sphere of radius N that has its center at T and is thus tangent to the ellipsoid at P and to all the points on the parallel PS. The equation of this circle in the meridian plane is:

$$x'^2 + z'^2 - 2Nz' = 0 \quad (3.154)$$

where the origin is at P. The corresponding equation for the tangent sphere would be:

$$x'^2 + y'^2 + z'^2 - 2Nz' = 0 \quad (3.155)$$

The meridian ellipse is the curve which is tangent at P where the line $x'\cos\phi - z'\sin\phi = 0$ cuts the circle $x'^2 + z'^2 - 2Nz' = 0$. Therefore the equation of the meridian ellipse in this local coordinate system takes the form:

$$x'^2 + z'^2 - 2Nz' + \delta(x'\cos\phi - z'\sin\phi)^2 = 0 \quad (3.156)$$

An ellipsoid equation must reduce to (3.156) when $y' = 0$. Therefore the general equation for an ellipsoid could be written as:

$$x'^2 + z'^2 - 2Nz' + \delta(x'\cos\phi - z'\sin\phi)^2 + f(y') = 0 \quad (3.157)$$

Letting $\delta = 0$ and comparing (3.157) with (3.155) we have $f(y') = y'^2$ so that the equation of the ellipsoid will be:

$$x'^2 + y'^2 + z'^2 - 2Nz' + \delta(x'\cos\phi - z'\sin\phi)^2 = 0 \quad (3.158)$$

Tobey (ibid. Proposition I) shows that $\delta = e'^2$ which was defined earlier. Equation (3.158) is viewed as an alternate form to (3.153) for the equation of the rotational ellipsoid.

4. CURVES ON THE SURFACE OF THE ELLIPSOID

4.1 Normal Sections

4.11 Introduction

We have previously defined a normal section as a curve formed by the intersection of a plane that contains the normal at a given point to the surface of the ellipsoid. A specific normal section from point A to point B is one formed by the intersection of a plane containing the normal at point A and that passes through point B, with the surface of the reference ellipsoid.

Physically, the normal section can be viewed when a theodolite is leveled with respect to the normal of the ellipsoid at the point at which the theodolite is set up. A normal plane is the plane swept out by moving the telescope in a vertical direction. By sighting on a distant object, we define a plane that contains the normal at the observation site, and passes through the observed site. The intersection of this plane with the ellipsoid forms the normal section from the observation point to the observed point.

In the following figure we indicate the normal sections from A to B, and then B to A, noting that, in general, such sections are different because the normals to the ellipsoid at different latitudes intersect the minor axis at different places. The two different sections are sometimes called counter-normal sections.

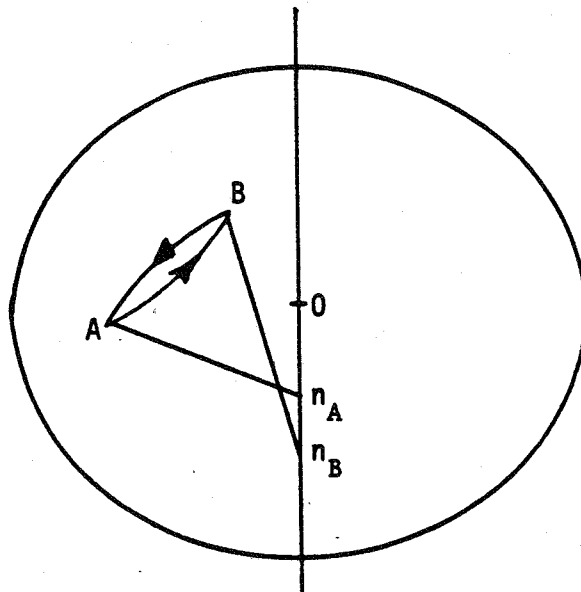

The distance On_A and On_B may be computed by considering the following diagram that is a meridian section through A.

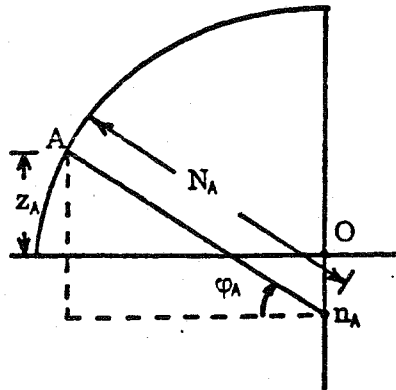

Figure 4.1
The Determination of the Distance On_A

We have:

$$On_A = N_A \sin \phi_A - Z_A \quad (4.1)$$

Using equation (3.39) for z we have:

$$On_A = N_A \sin \phi_A - N_A (1-e^2) \sin \phi_A = e^2 N_A \sin \phi_A \quad (4.2)$$

Similarly:

$$On_B = e^2 N_B \sin \phi_B \quad (4.3)$$

If $\phi_A > \phi_B$, $On_A > On_B$. From this it follows that the more northerly the location of the point through which the normal is passed, the larger the On , and the further to the south is the axis of rotation intersected by the normal. Thus if A is to the south of B, the normal section from A to B will be to the south of the normal section from B to A. The line from the northern point to the southern point will always lie to the north of the curve from the southern point to the northern point.

The fact of having, in general, two normal sections between two points creates problems when direction observations are being used in the computations. This may be seen from the following figure where the observed lines are indicated for a triangle on the surface of the ellipsoid.

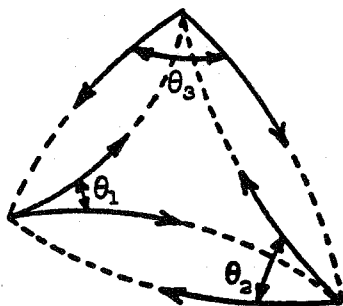

Figure 4.2
A Normal Section "Triangle"

The measured angles are θ_1 , θ_2 , and θ_3 . It is evident from this figure that no closed figure has been observed.

Finally, we consider two cases where there is only one normal section between two points. The first occurs when the two points are on a meridian. The second case occurs when the two points are on the same parallel. The first case occurs because the meridian is a planar curve. The second case is clear because normals at the same latitude intersect the minor axis at the same point.

4.12 The Separation Between Reciprocal Normal Sections

We will be ultimately interested in the azimuth differences and distance differences between reciprocal normal sections. Before we consider these quantities, we derive an expression for the angle f which is the angle between the intersecting normal section planes. This angle is shown in Figure 4.3.

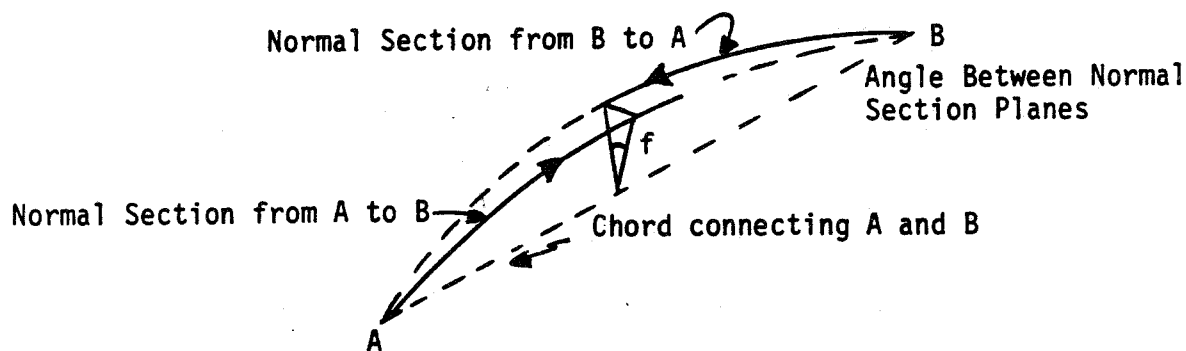

Figure 4.3
The Angle Between the Reciprocal Normal Sections
at the Chord Connecting Them

In order to find this angle consider Figure 4.4

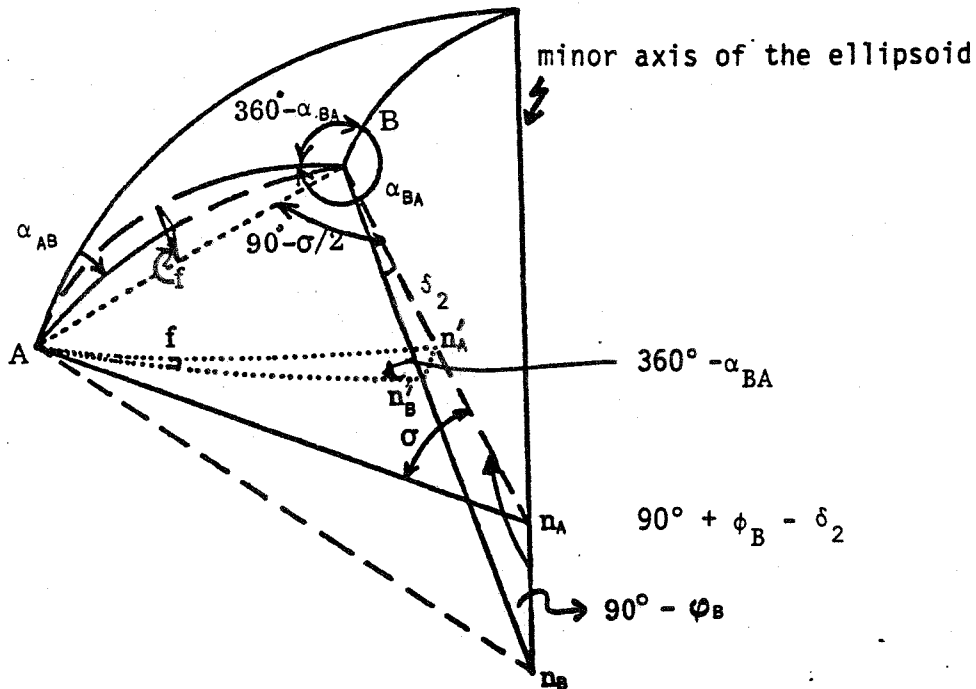

Figure 4.4
Normal Section Geometry

Angle α_{AB} is the normal section azimuth from A to B at A, while α_{BA} is the normal section azimuth from B to A at B. σ is the angle between straight lines n_A and n_B . δ_2 is the angle $n_A B n_B$. n_A and n_B lie on the meridian plane through B.

Since $n_A \approx n_B$, triangle $n_A n_B$ is approximately an isosceles triangle. Consequently, angle $n_B n_A$ is approximately $90^\circ - \frac{\sigma}{2}$.

We next construct arcs n_A' and n_B' , from point B as center. The arc $n_A' n_B'$ will be in the meridian through B and will be of length δ_2 . Consequently the interior angle $n_A' n_B' A$ will be $360^\circ - \alpha_{BA}$. The arc $n_A' A$ will be $90^\circ - \frac{\sigma}{2}$.

The angle $n_A' A n_B'$ will be equal to the angle f which we want to evaluate.

Applying the law of sines to the triangle $n_A' A n_B'$ we have:

$$\frac{\sin f}{\sin \delta_2} = \frac{\sin(360^\circ - \alpha_{BA})}{\sin(90^\circ - \frac{\sigma}{2})} \quad (4.4)$$

or solving for $\sin f$

$$\sin f = \frac{-\sin\delta_2 \sin\alpha_{BA}}{\sin(90^\circ - \frac{\sigma}{2})} \quad (4.5)$$

From the plane triangle $Bn_A n_B$ we have:

$$\frac{\sin\delta_2}{n_A n_B} = \frac{\sin(90^\circ + \phi_B - \delta_2)}{Bn_B} \quad (4.6)$$

where ϕ_B is latitude of point B. To find $n_A n_B$ we subtract equation (4.2) from (4.3):

$$n_A n_B = On_B - On_A = e^2(N_B \sin\phi_B - N_A \sin\phi_A) \quad (4.7)$$

Substituting for N and neglecting terms on the order of $ae^4(\phi_A - \phi_B)$ we find:

$$n_A n_B = ae^2(\phi_B - \phi_A) \cos\phi_m \quad (4.8)$$

where ϕ_m is the mean latitude.

Expanding the multiple angle expression in (4.6) we have:

$$\sin\delta_2 = \frac{n_A n_B}{Bn_B} \cos\phi_B \cos\delta_2 + \sin\phi_B \frac{n_A n_B}{Bn_B} \sin\delta_2 \quad (4.9)$$

Substitute (4.8) into (4.9), neglect the right most term, and noting $Bn_B = N_B$, we have:

$$\sin\delta_2 = \frac{ae^2(\phi_B - \phi_A) \cos\phi_B \cos\phi_m}{N_B} \quad (4.10)$$

With an error on the order of $e^4(\phi_B - \phi_A)$ we take (a/N_B) equal to one and write:

$$\sin\delta_2 = e^2(\phi_B - \phi_A) \cos\phi_B \cos\phi_m \quad (4.11)$$

Jordan (1962) has given a closed expression to determine δ_2 and a series form more accurate than (4.11). The closed form is Jordan (ibid, Volume III, 2, p. 3):

$$\tan \delta_2 = \frac{e^2(\sin \phi_B - \sin \phi_A \frac{V_B}{V_A}) \cos \phi_B}{1 - e^2(\sin \phi_B - \sin \phi_A \frac{V_B}{V_A}) \sin \phi_B} \quad (4.12)$$

The series form is (ibid, p. 3):

$$\delta_2 = \eta^2 \frac{\Delta \phi}{V_B^2} + \frac{\eta^2 t_B}{2} \frac{\Delta \phi^2}{V_B^4} - \frac{\eta^2}{6} \frac{\Delta \phi^3}{V_B^6} - \frac{\eta^2 t_B}{24} \frac{\Delta \phi^4}{V_B^8} + \dots \quad (4.13)$$

where $\eta^2 = e^2 \cos^2 \phi$ (4.14)
 $t = \tan \phi$

Substituting equation (4.11) into (4.5) we have:

$$\sin f = \frac{-e^2(\phi_B - \phi_A) \cos^2 \phi_m \sin \alpha_{BA}}{\cos \frac{\sigma}{2}} \quad (4.15)$$

where we have assumed $\phi_B = \phi_m$.

In order to find σ we consider an approximation of sufficient accuracy. We take a small spherical triangle as shown in Figure 4.5:

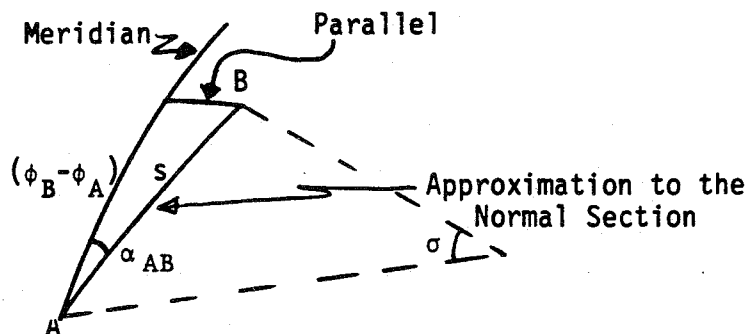

Figure 4.5
 An Approximation for the Spherical Arc σ

From the triangle we have approximately:

$$(\phi_B - \phi_A) = \sigma \cos \alpha_{AB} \quad (4.16)$$

Assuming $\alpha_{21} = \alpha_{12} \pm 180^\circ$ (i.e. ignoring meridian convergence as we are dealing with lines of the length 50-100 km), letting $\cos \frac{\sigma}{2} \approx 1$, $f \approx \sin f$, and substituting equation (4.16) into (4.15) we find:

$$f = \frac{1}{2} e^2 \sigma \cos^2 \phi_m \sin 2\alpha_{AB} \quad (4.17)$$

A reasonable approximation for σ is s/N_A where s is the length of the normal section. Then:

$$f = \frac{1}{2} e^2 \left(\frac{s}{N_A} \right) \cos^2 \phi_m \sin 2\alpha_{AB} \quad (4.18)$$

From (4.18) we see that f increases linearly with distance. It will decrease as latitude increases and it will be a maximum for lines having azimuths as odd multiples of 45° . For $s = 100$ km, $\phi_m = 45^\circ$, and $\alpha_{12} = 45^\circ$, $f = 5.4''$.

4.13 Linear Separation of Reciprocal Normal Sections

We now consider the linear separation between the normal sections. We consider the following figure, where, with sufficient accuracy the arcs AaB and AbB can be regarded as spherical arcs with centers at n_a and n_b .

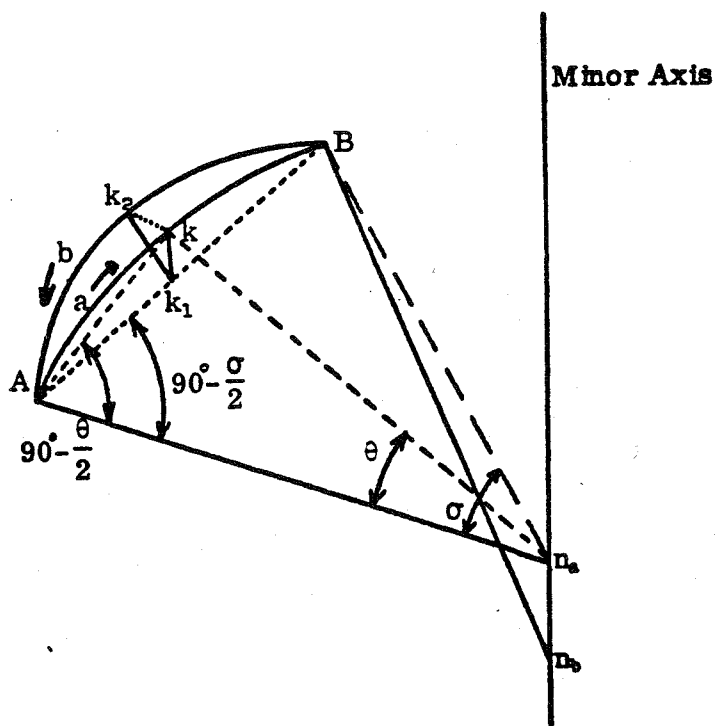

Figure 4.6
Geometry of the Linear Separation of the Normal Section

Point k is an arbitrary point on the normal section A to B, θ is the angle, analogous to σ , kn_aA . As k varies in position between A and B, θ varies from 0 to σ . We have:

$$\text{angle } BAn_a = 90^\circ - \frac{\sigma}{2} \quad (4.19)$$

$$\text{angle } kAn_a = 90^\circ - \frac{\theta}{2}$$

$$\text{angle } kAB = kAn_a - BAn_a = \frac{\sigma - \theta}{2} \quad (4.20)$$

From Figure 4.6 we have:

$$Ak = 2N_A \sin \frac{\theta}{2} \quad (4.21)$$

Now consider a triangle whose vertex is on the chord:

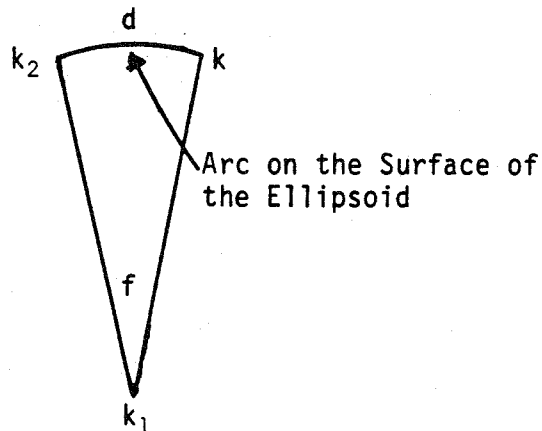

Figure 4.7
Linear Separation

From Figure 4.7 we have:

$$kk_2 = d = kk_1 \cdot f \quad (4.22)$$

where d is the linear separation desired. We have:

$$kk_1 = Ak \sin kAB = 2N_A \sin \frac{\theta}{2} \sin \frac{\sigma - \theta}{2} \quad (4.23)$$

using equations (4.20) and (4.21). Using equations (4.18) and (4.23) in equation (4.22) we find:

$$d = e^2 s \sin \frac{\theta}{2} \sin \frac{\sigma - \theta}{2} \cos^2 \phi_m \sin 2\alpha_{AB} \quad (4.24)$$

Assuming σ and θ are small, equation (4.24) may be written:

$$d = \frac{e^2}{4} s \theta (\sigma - \theta) \cos^2 \phi_m \sin 2\alpha_{AB} \quad (4.25)$$

The maximum separation will occur at $\theta = \frac{\sigma}{2}$ which upon substitution into equation (4.25) yields:

$$d_{\max} = \frac{e^2}{16} s \sigma^2 \cos^2 \phi_m \sin 2\alpha_{AB} \quad (4.26)$$

or upon substituting for σ :

$$d_{\max} = \frac{e^2}{16} \frac{s^3}{N_A^2} \cos^2 \phi_m \sin 2\alpha_{AB} \quad (4.27)$$

Equation (4.27) breaks down in principle when the two points are located on the same parallel as the separation d should be zero in this case. However, the result obtained will be correct to the accuracy of the derivation. A more exact formula is given by Zakatov (1962, p. 53)

$$d_{\max} = N_A \frac{e^2 \sigma^3}{8} \sin \alpha_{AB} \cos^2 \phi_A \left(\cos \alpha_{AB} - \frac{\sigma}{2} \tan \phi_A \right) \quad (4.28)$$

We now consider some numerical examples using 4.27:

<u>Case 1</u> $\phi_m = 45^\circ, \alpha_{AB} = 45^\circ$			
s	200 km	100 km	50 km
$d_{\max}(m)$	0.050 m	0.006 m	0.0008 m
<u>Case 2</u> $\phi_m = 52^\circ, \alpha_{AB} = 45^\circ$			
s	150 km	100 km	20 km
$d_{\max}(m)$.013 m	0.0038 m	0.0001 m

Clearly this linear separation is very small and does not have any practical significance.

4.14 Azimuth Separation of Reciprocal Normal Section

We designate the angle between the normal sections, measured tangent to the normal sections as Δ . This angle is also the difference between the azimuths of the two normal sections as may be seen in Figure 4.8:

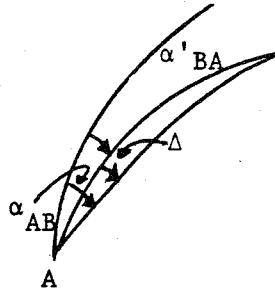

Figure 4.8
Normal Section Azimuth Separation

We have:

$$\Delta = \alpha_{AB} - \alpha'_{AB} \quad (4.29)$$

where α'_{AB} is the azimuth of the normal section from B to A at point A.

From Figure 4.6 we can write:

$$\text{angle } kAk_2 = \frac{kk_2}{Ak} \quad (4.30)$$

or using equation (4.25) for kk_2 and letting $Ak = N_A \theta$ we have:

$$\begin{aligned} \text{angle } kAk_2 &= \frac{e^2 s(\sigma - \theta)}{4N_A} \cos^2 \phi_m \sin 2\alpha_{AB} \\ &= \frac{e^2}{4} \sigma(\sigma - \theta) \cos^2 \phi_m \sin 2\alpha_{AB} \end{aligned} \quad (4.31)$$

To obtain the angle Δ we let θ go to zero so that angle kAk_2 , in the limit, goes to the desired angle. We then have:

$$\Delta = \frac{e^2 \sigma^2 \cos^2 \phi_m \sin 2\alpha_{AB}}{4} = \frac{e^2}{4} \left(\frac{s}{N_A} \right)^2 \cos^2 \phi_m \sin 2\alpha_{AB} \quad (4.32)$$

Note that (4.32) breaks down when the two points are on the same parallel as did (4.27). In this case a more accurate expression for Δ is needed. From Jordan (Vol. III, 2nd half, p. 16) we have:

$$\Delta = \frac{e^2}{2} \sin \alpha_{AB} \left(\frac{s}{N_A} \right)^2 \cos^2 \phi_A \left(\cos \alpha_{AB} - \frac{\tan \phi_A}{2} \frac{s}{N_A} \right) \quad (4.33)$$

One can show that the right most expression in (4.33) is essentially zero for close points on the same parallel.

Sample values of Δ computed from (4.33) are shown below:

<u>Case One</u>	$\phi_A = 0^\circ, \alpha_{AB} = 45^\circ$		
s	200 km	100 km	50 km
Δ "	0.339	0.085	0.021

<u>Case Two</u>	$\phi_A = 52^\circ, \alpha_{AB} = 45^\circ$		
s	150 km	100 km	30 km
Δ "	0.071	0.032	0.003

Generally for distances up to 20 - 25 km it is not necessary to consider the angular separation of normal sections. For distances beyond this, it is usually necessary to make appropriate corrections using equations such as (4.33).

4.15 The Elliptic Arc of a Normal Section

In the derivation in the past section we interchanged σ and (s/N_A) , in several cases. It is appropriate to consider a more rigorous relationship between σ and s . We first consider Figure 4.9.

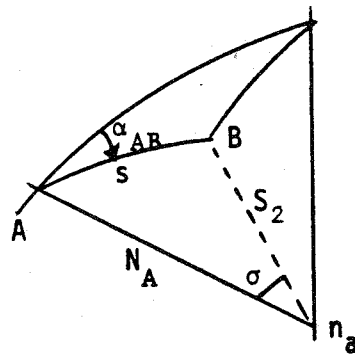

Figure 4.9
The Elliptic Arc of a Normal Section

We have s , the normal section distance, σ the angle An_B , and S_2 , the distance n_B . After some manipulation, it can be shown (Jordan, second half, Vol. III, p. 11) that:

$$\frac{S_2}{N_A} = 1 - \frac{1}{2}\sigma^2 \eta_A^2 \cos^2 \alpha_{AB} + \frac{1}{2}\sigma^3 \eta_A^2 t_A \cos \alpha_{AB} + \dots \quad (4.34)$$

where:

$$\eta_A^2 = e'^2 \cos^2 \phi_A$$

$$t_A = \tan \phi_A$$

We now wish to calculate a differential distance ds along the normal section arc. To do this consider Figure 4.10:

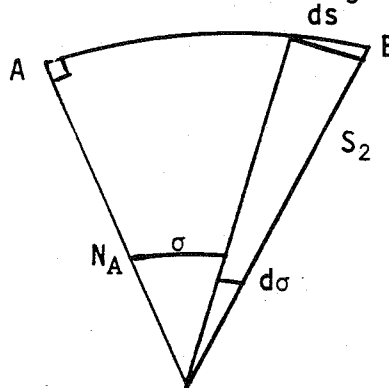

Figure 4.10

The Differential Element on the Elliptical Arc

We have:

$$ds^2 = (S_2 d\sigma)^2 + (dS_2)^2 \quad (4.35)$$

The first term can be written from (4.34) as (and dropping the subscript A and AB for convenience):

$$(S_2 d\sigma)^2 = N^2 (1 - \sigma^2 \eta^2 \cos^2 \alpha + \sigma^3 \eta^2 t \cos \alpha + \frac{1}{4} \sigma^4 \eta^4 \cos^4 \alpha$$

$$- \frac{1}{2} \sigma^5 \eta^4 t \cos^3 \alpha + \frac{1}{4} \sigma^6 \eta^4 t \cos^2 \alpha) d\sigma^2 \quad (4.36)$$

We then differentiate (4.34) regarding σ as the variable. Squaring the result yields:

$$(dS_2)^2 = N^2(\eta^4 \cos^4 \alpha \sigma^2 - 3\eta^4 t \cos^3 \alpha \sigma^3 + \frac{9}{4} \eta^4 t^2 \cos^2 \alpha \sigma^4) d\sigma^2 + \dots \quad (4.37)$$

Taking the square root of the sum represented by (4.35) we have:

$$\begin{aligned} ds &= N d\sigma + \frac{1}{2} N \eta^2 \cos^2 \alpha (\eta^2 \cos^2 \alpha) \sigma^2 d\sigma \\ &\quad - \frac{N}{2} \eta^2 \cos^2 \alpha \sigma^2 d\sigma + \frac{N}{2} \eta^2 t \cos \alpha \sigma^3 d\sigma \\ &\quad - \frac{3N}{2} \eta^4 t \cos^3 \alpha \sigma^3 d\sigma \end{aligned} \quad (4.38)$$

We now integrate this expression from 0 to s and correspondingly from 0 to σ to find:

$$\begin{aligned} s &= N_A \sigma \left(1 + \frac{1}{6} \sigma^2 \eta_A^2 \cos^2 \alpha_{AB} (\eta_A^2 \cos^2 \alpha_{AB} - 1) \right) \\ &\quad + \frac{1}{8} \eta_A^2 t \cos \alpha_{AB} (1 - 3 \eta_A^2 \cos^2 \alpha_{AB}) \sigma^3 \end{aligned} \quad (4.39)$$

Using (2.10) we can invert this equation to obtain:

$$\begin{aligned} \sigma &= \frac{s}{N_A} \left(1 + \frac{1}{6} \eta_A^2 \cos^2 \alpha_{AB} (1 - \eta_A^2 \cos^2 \alpha_{AB} \left(\frac{s}{N_A}\right)^2) \right. \\ &\quad \left. - \frac{1}{8} \eta_A^2 t \cos \alpha_{AB} (1 - 3 \eta_A^2 \cos^2 \alpha_{AB}) \left(\frac{s}{N_A}\right)^3 + \dots \right) \end{aligned} \quad (4.40)$$

4.16 Azimuth Correction due to Height of Observed Point

When directions are actually measured, with, for example, a theodolite, they are measured between points located on the surface of the earth. However, geodetic computations are generally carried out on the surface of the reference ellipsoid. It is thus necessary to correct the observations, where appropriate, for any effects caused by going from the earth's surface to the reference ellipsoid. One effect considered in this section is that caused by the height of the point being observed.

To consider this effect, a point A is located on the reference ellipsoid and point B located at an elevation h. We level the theodolite at A and pass a plane, normal at A, through the elevated point B. The azimuth of the point would be designated as A_h . This azimuth, however, is not the azimuth desired since the desired azimuth is one to the point b projected onto the reference ellipsoid. We let this azimuth be A. Since the ellipsoid is slightly flattened, the difference, $(A - A_h)$, that is to be determined, is small.

In order to compute this difference, we consider Figure 4.11.

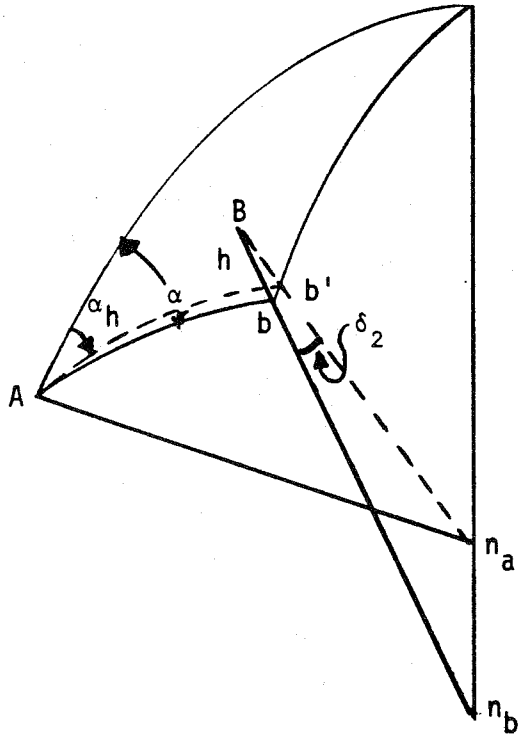

Figure 4.11
Azimuth Effect for a Point Elevated Above the Ellipsoid

The projection of B onto the ellipsoid point b is found by finding point b, on the ellipsoid, where the normal passes through B. Point b' is a point on the ellipsoid determined by the intersection of the normal plane at A passing through B, with the meridian of b. Angle δ_2 is the angle $n_a B n_b$. With sufficient accuracy, we can associate δ_2 with δ_2 that was given in equation (4.11). We write for this purpose, equation (4.11) in the form:

$$\delta_2 = e^2 \Delta \phi \cos^2 \phi_m \quad (4.41)$$

where $\Delta \phi$ is the latitude difference ($\phi_B - \phi_A$). We now rewrite equation (4.16) by letting, with sufficient accuracy, $\sigma = s/M_m$, where M_m is the meridian radius of curvature at the mean latitude ϕ_m . We then have:

$$\Delta \phi = \frac{s}{M_m} \cos \alpha_{AB} \quad (4.42)$$

which may be substituted into (4.41) to give:

$$\delta_2 = \frac{s}{M_m} e^2 \cos^2 \phi_m \cos \alpha_{AB} \quad (4.43)$$

The arc bb' is then $h\delta_2$ so:

$$bb' = \frac{hs}{M_m} e^2 \cos^2 \phi_m \cos \alpha_{AB} \quad (4.44)$$

We now consider, in the following figure, the triangle $b'A'b$.

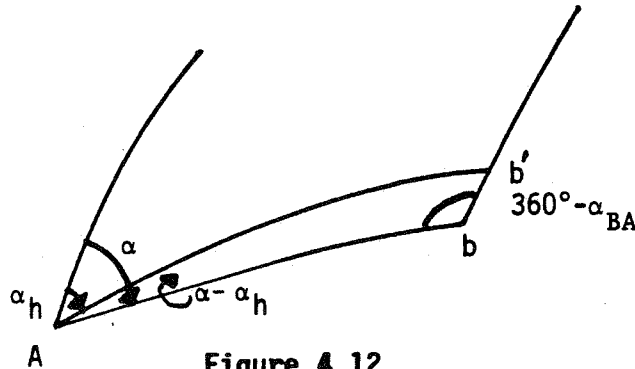

Figure 4.12
Small Triangle for Height Effect Determination

We apply the law of sines to write (assuming a plane figure) since we are dealing with relatively small triangles on the ellipsoid).

$$\frac{\sin(\alpha - \alpha_h)}{bb'} = \frac{\sin(360^\circ - \alpha_{BA})}{s} \quad (4.45)$$

Substituting equation (4.44) into (4.42) and letting:

$$\sin(\alpha - \alpha_h) \approx \alpha - \alpha_h$$

$$\sin(360^\circ - \alpha_{BA}) \approx \sin \alpha_{AB}$$

we find:

$$\alpha - \alpha_h = \frac{h}{2M_m} e^2 \cos^2 \phi_m \sin 2\alpha_{AB} \quad (4.46)$$

Equation (4.46) gives the desired correction. Thus, the corrected azimuth α obtained from the measured azimuth is:

$$\alpha = \alpha_h + \frac{h}{2M_m} e^2 \cos^2 \phi_m \sin 2\alpha_{AB} \quad (4.47)$$

A more accurate expression for $\alpha - \alpha_h$ is found in Jordan (III, part 2, p. 20) as:

$$\alpha - \alpha_h = \frac{h}{N_A} \eta_A^2 (\sin \alpha_{AB} \cos \alpha_{AB} - \frac{S}{2N_A} \sin \alpha_{AB} \tan \phi_A) \quad (4.48)$$

We notice that to a first approximation, the correction being computed does not depend on the separation of the two points. In addition, if the eccentricity of the ellipsoid is zero, the correction is zero. Thus, the correction would not exist for a sphere. In fact, the main reason that the correction exists is because ellipsoid normals at different latitudes intersect the minor axis at different locations.

We consider two numerical estimates:

If $\phi_m = 45^\circ$, for $h = 1000$ m, $\alpha - \alpha_h \leq 0''.05$; for $h = 200$ m, $\alpha - \alpha_h \leq 0''.008$.

Jordan (III, part 2, p. 20) gives the following example for a line measured from Spain to North Africa:

$$\phi_1 = 35^\circ 01'$$

$$\alpha_{AB} = 327^\circ 40'$$

$$h = 3482 \text{ m}$$

$$s = 269926 \text{ m}$$

Then equation (4.48) has been evaluated to yield:

$$\alpha - \alpha_h = -0''.2291 + 0''.0040 = -0''.2251$$

This "height of tower" correction should always be considered when reducing observations, although it is generally only appropriate in higher elevations. However, the neglect of the correction for lower elevations could cause systematic errors when triangulation computations are taking place.

Finally, we recall that in our derivations we assumed point A was located on the surface of the reference ellipsoid. If point A was elevated, our argument would not be altered since the directions at A are measured with respect to the normal at A. Thus the correction $\alpha - \alpha_h$ is not dependent on the height of the observing station.

4.17 The Dip Angle of the Chord

Consider two points A and B on the ellipsoid that are connected by a normal section curve of length s . Let μ be the dip angle with respect to the tangent at A in the direction AB as shown in Figure 4.13.

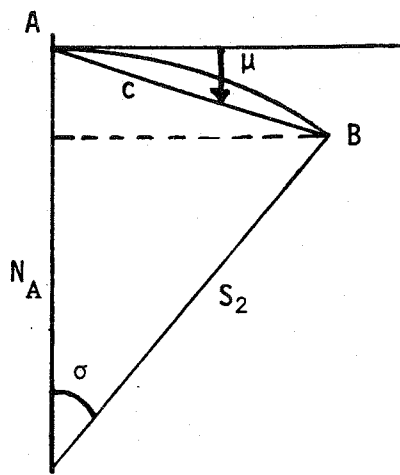

Figure 4.13
The Dip Angle

μ is measured positive downwards in this derivation. We have from Figure 4.13:

$$\tan(90^\circ - \mu) = \frac{S_2 \sin \sigma}{N_A - S_2 \cos \sigma} \quad (4.49)$$

or

$$\tan \mu \sin \sigma = \frac{N_A}{S_2} - \cos \sigma \quad (4.50)$$

We can re-write (4.50) by using N_A/S_2 determined from (4.34) and then expanding $\tan \mu$, $\sin \sigma$, and $\cos \sigma$. We have (Jordan, III, part 2, p. 12):

$$\mu = \frac{1}{2} \alpha (1 + \eta_A^2 \cos^2 \alpha_{AB}) - \frac{1}{2} \sigma^2 \eta_A^2 t_A \cos \alpha_{AB} \quad (4.51)$$

If we want an expression for μ in terms of s we can use (4.40) to write:

$$\mu = \frac{s}{2N_A} (1 + \eta_A^2 \cos^2 \alpha_{AB}) - \frac{s^2}{2N_A^2} \eta_A^2 t_A \cos \alpha_{AB} \quad (4.52)$$

We consider some numerical values of μ by considering a point where $\phi_A = 45^\circ$, and $\alpha_{AB} = 45^\circ$. We have for this case

s (km)	μ
10	2' 41"7
30	8' 5"09
50	13' 28"5
75	20' 12"7
100	26' 56"9

4.18 The Normal Section and Chord Length

Let the chord length between AB be c as seen in Figure 4.13. We write (Jordan, III, part 2, p. 12):

$$\frac{c}{N_A} = \frac{\sin \sigma}{\sin (\mu + 90^\circ - \sigma)} = \frac{\sin \sigma}{\cos(\sigma - \mu)} \quad (4.53)$$

Since σ is small we can expand the right side of (4.53):

$$\frac{c}{N_A} = \sigma \left(1 - \frac{\sigma^2}{6} + \frac{\sigma^4}{120} \right) \left(1 + \frac{1}{2}(\sigma - \mu)^2 + \frac{5}{24}(\sigma - \mu)^4 \dots \right) \quad (4.54)$$

We can obtain an expression for $\sigma - \mu$ from (4.51) so that (4.54) can be written as:

$$\frac{c}{N_A} = \sigma \left(1 - \frac{1}{24} \sigma^2 (1 + 6\eta_A^2 \cos^2 \alpha_{AB}) + \frac{1}{4} \sigma^3 \eta_A^2 t_A \cos \alpha_{AB} + \frac{1}{1920} \sigma^4 \dots \right) \quad (4.55)$$

If we introduce (4.40) one finds:

$$c = s \left(1 - \frac{1}{24} \frac{s^2}{N_A^2} (1 + 2\eta_A^2 \cos^2 \alpha_{AB}) + \frac{1}{8} \frac{s^3}{N_A^3} \eta_A^2 t_A \cos \alpha_{AB} + \frac{1}{1920} \frac{s^4}{N_A^4} \right) \quad (4.56)$$

Equation (4.56) can be inverted using (2.10) to find the normal section distance given the chord distance. We find:

$$s = c \left(1 + \frac{1}{24} \frac{c^2}{N_A^2} (1 + 2\eta_A^2 \cos^2 \alpha_{AB}) - \frac{1}{8} \frac{c^3}{N_A^3} \eta_A^2 t_A \cos \alpha_{AB} + \frac{3}{640} \frac{c^4}{N_A^4} \right) \quad (4.57)$$

Bagratuni (1967, p. 77) gives a more accurate formula for the chord to normal section distance as follows:

$$s = c \left(1 + \frac{1}{6} \left(\frac{c}{2r} \right)^2 + \frac{3}{40} \left(\frac{c}{2r} \right)^4 + \frac{5}{112} \left(\frac{c}{2r} \right)^6 + \frac{\mu_1}{2} \left(\frac{c}{2r} \right)^3 + \frac{3}{5} \mu_2 \left(\frac{c}{2r} \right)^4 + \dots \right) \quad (4.58)$$

where:

$r^2 = x_1^2 + y_1^2 + z_1^2$, the geodetic radius to the first point;

$$\mu_1 = \frac{e'^2 \sin 2\phi_A \cos \alpha_{AB}}{1 + \eta_A^2 \cos^2 \alpha_{AB}} \quad (4.59)$$

$$\mu_2 = \frac{e'^2 (\sin^2 \phi_A - \cos^2 \phi_A \cos^2 \alpha_{AB})}{1 + \eta_A^2 \cos^2 \alpha_{AB}}$$

The accuracy of these formulas depends primarily on the length of the line. For example, the last term in (4.57) times c has a value of 9 mm with $c = 200$ km, and 68 mm for $c = 300$ km.

4.19 The Normal Section in a Local Coordinate System

Consider two points A and B located on or above the ellipsoid. The space rectangular coordinates of these two points can be determined from equation (3.152) assuming that we know the latitude, longitude and height above the ellipsoid of each point.

We now introduce a local u, v, w coordinate system where the origin for this system is at point A . The (primary) w axis is in the direction of the normal to the ellipsoid at point A . The u axis is perpendicular to the w axis in the north direction defined by the geodetic meridian. The v axis is perpendicular to the u - w plane in a positive east direction. These axes are shown in Figure 4.14.

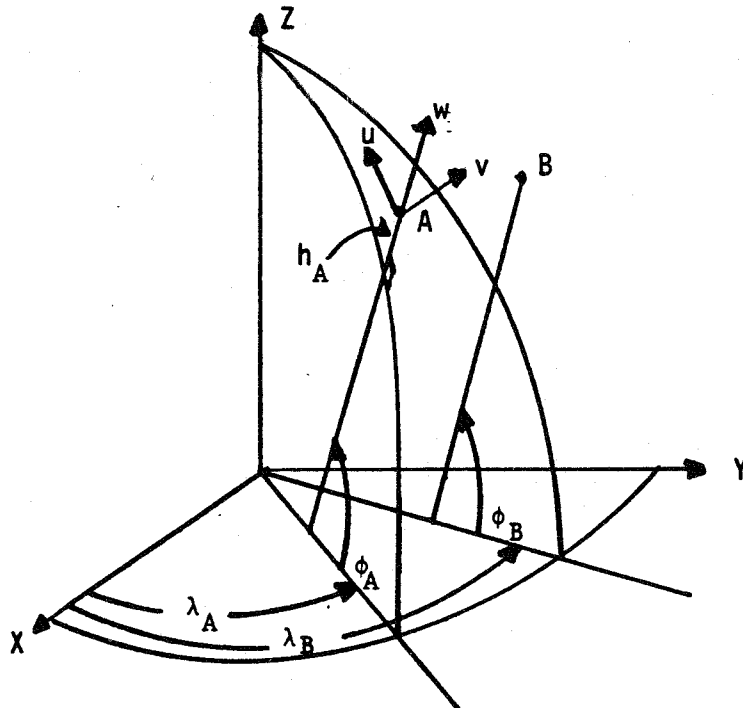

Figure 4.14
Space Rectangular and Local Coordinate Systems

The local coordinate system can also be viewed in terms of the "observations" of the chord distance c , the vertical angle V , and the normal section azimuth, α , from A to B as shown in Figure 4.15

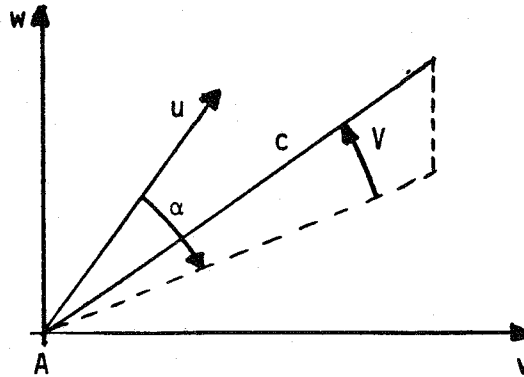

Figure 4.15
The Local Coordinate System

Note that the uv plane forms the local geodetic horizon plane. The vertical angle, V , can be regarded as a generalization of the dip angle, μ , described in section 4.17, but with opposite sign. Note that, with the direction chosen for v , this system forms a left-handed coordinate system since u is considered the primary (1) axis, v the secondary and w the tertiary axis. If v were chosen in the opposite direction the system would be right handed.

From Figure 4.15 we can determine the u , v , w coordinates from α , V , and c as follows:

$$\begin{aligned} u &= c \cos V \cos \alpha \\ v &= c \cos V \sin \alpha \\ w &= c \sin V \end{aligned} \tag{4.60}$$

Dividing the first two equations we have:

$$\tan \alpha = \frac{v}{u} \tag{4.61}$$

where we again note that α is a normal section azimuth.

We now wish to express the local coordinates in terms of the space rectangular coordinate differences ($\Delta X = X_B - X_A$, $\Delta Y = Y_B - Y_A$, $\Delta Z = Z_B - Z_A$). To do this we first translate the X , Y , Z axes to a parallel set of axes whose origin is at point A as shown in Figure 4.16:

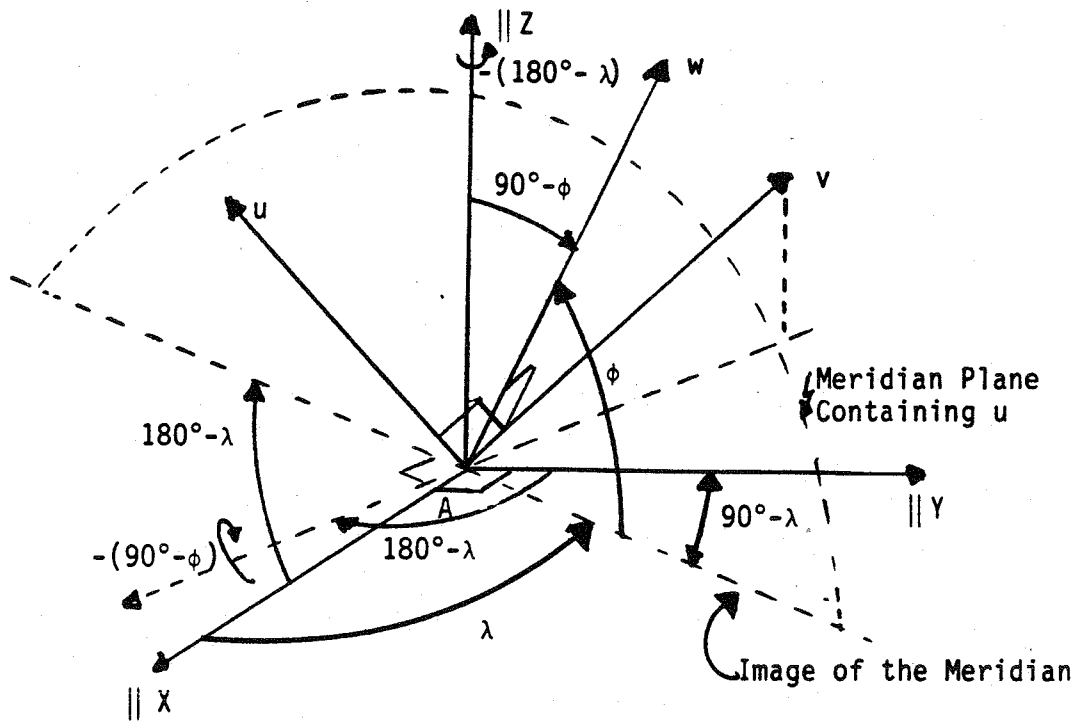

Figure 4.16
The Translated X, Y, Z Axis at Point A

Now the general rotation between two rectangular coordinate systems that have the same origin can be written in the form:

$$\begin{pmatrix} x'' \\ y'' \\ z'' \end{pmatrix} = R_1(\theta_x) R_2(\theta_y) R_3(\theta_z) \begin{pmatrix} x' \\ y' \\ z' \end{pmatrix} \quad (4.62)$$

where $\theta_x, \theta_y, \theta_z$ are the rotations about the x', y', z' .

The orthogonal rotation matrices are:

$$R_1(\theta) = \begin{pmatrix} 1 & 0 & 0 \\ 0 & \cos \theta & \sin \theta \\ 0 & -\sin \theta & \cos \theta \end{pmatrix} \quad (4.63)$$

$$R_2(\theta) = \begin{pmatrix} \cos \theta & 0 & -\sin \theta \\ 0 & 1 & 0 \\ \sin \theta & 0 & \cos \theta \end{pmatrix} \quad (4.64)$$

$$R_3(\theta) = \begin{pmatrix} \cos \theta & \sin \theta & 0 \\ -\sin \theta & \cos \theta & 0 \\ 0 & 0 & 1 \end{pmatrix} \quad (4.65)$$

This conversion is for a right handed coordinate system with positive rotations for clockwise rotation as viewed looking from the origin toward the positive axis (Mueller, 1969).

In our specific application to the (') coordinates refer to ΔX , ΔY , ΔZ , and the (") coordinates refer to u , $-v$, w , since $-v$ forms a right hand system. In our case the rotations can be accomplished with a rotation of $-(180^\circ - \lambda_A)$ about the $||Z$ axis and then a rotation of $-(90^\circ - \phi_A)$ about the new $||Y$ axis. We have:

$$\begin{pmatrix} u \\ -v \\ w \end{pmatrix} = R_2(-(90^\circ - \phi_A))R_3(-(180^\circ - \lambda_A)) \begin{pmatrix} \Delta X \\ \Delta Y \\ \Delta Z \end{pmatrix} \quad (4.66)$$

Multiplying out these matrices we have:

$$\begin{pmatrix} u \\ v \\ w \end{pmatrix} = \begin{pmatrix} -\sin \phi_A \cos \lambda_A & -\sin \phi_A \sin \lambda_A & \cos \phi_A \\ -\sin \lambda_A & \cos \lambda_A & 0 \\ \cos \phi_A \cos \lambda_A & \cos \phi_A \sin \lambda_A & \sin \phi_A \end{pmatrix} \begin{pmatrix} \Delta X \\ \Delta Y \\ \Delta Z \end{pmatrix} \quad (4.67)$$

In terms of individual coordinates:

$$u = -\sin \phi_A \cos \lambda_A \Delta X - \sin \phi_A \sin \lambda_A \Delta Y + \cos \phi_A \Delta Z \quad (4.68)$$

$$v = -\sin \lambda_A \Delta X + \cos \lambda_A \Delta Y \quad (4.69)$$

$$w = \cos \phi_A \cos \lambda_A \Delta X + \cos \phi_A \sin \lambda_A \Delta Y + \sin \phi_A \Delta Z \quad (4.70)$$

If we use (4.68) and (4.69) in (4.61) we have:

$$\tan \alpha = \frac{-\sin \lambda_A \Delta X + \cos \lambda_A \Delta Y}{-\sin \phi_A \cos \lambda_A \Delta X - \sin \phi_A \sin \lambda_A \Delta Y + \cos \phi_A \Delta Z} \quad (4.71)$$

If we use (4.70) in the last of (4.60) we have:

$$\sin V = \frac{1}{c} (\cos \phi_A \cos \lambda_A \Delta X + \cos \phi_A \sin \lambda_A \Delta Y + \sin \phi_A \Delta Z) \quad (4.72)$$

The chord distance can be computed from:

$$c = (u^2 + v^2 + w^2)^{\frac{1}{2}} = (\Delta X^2 + \Delta Y^2 + \Delta Z^2)^{\frac{1}{2}} \quad (4.73)$$

From the equations in this section we see a procedure to consider the normal section and related quantities using closed expressions as opposed to the many series expressions used previously. The equations developed in this section will be used later in developing procedures for the calculation of geodetic positions on the ellipsoid. Note, however, that in the equations derived here the points can be at any height above the ellipsoid.

4.2 The Geodesic Curve

To this point, we have primarily considered the normal section which was a plane curve on the surface of the reference ellipsoid. We saw that using the normal section had the disadvantage of not being unique between two points. We now examine a curve, called the geodesic, for which there is only one between any two points.

The fundamental definition of a geodesic curve is a curve which gives the shortest distance, on a surface, between any two points. If the surface is a plane, the geodesic is a straight line; if the surface is a sphere, the geodesic is a great circle. On the ellipsoid, the geodesic is a curve having a double curvature and is thus not a plane curve.

To begin, we consider the construction of the geodesic on the surface of the ellipsoid. We first level our theodolite with respect to point A and then aim at a distant point B defining the normal section curve AaB. We then go to B, level the theodolite, point at A to define the normal section BbA, we then turn the theodolite by 180° and define a new point C and the normal section BbC. We repeat the operation by going to point C, point D and subsequent points. This construction is shown in Figure 4.16.

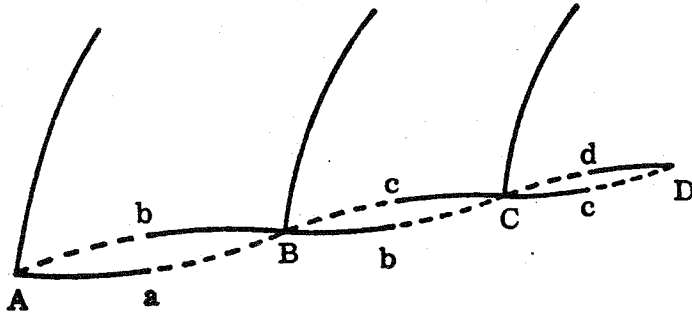

Figure 4.16
Normal Sections Between Close Points

We know that the separation of the normal section lines is small and becomes smaller as the separation between the points decreases. If we let the distance AB, BC, CD, etc. become smaller and smaller, a unique curve will be obtained between the points. This curve is the geodesic.

If we had two points A and B, we could construct the geodesic between two points if we knew the appropriate azimuth of a starting segment. Such a curve has been constructed in Figure 4.17.

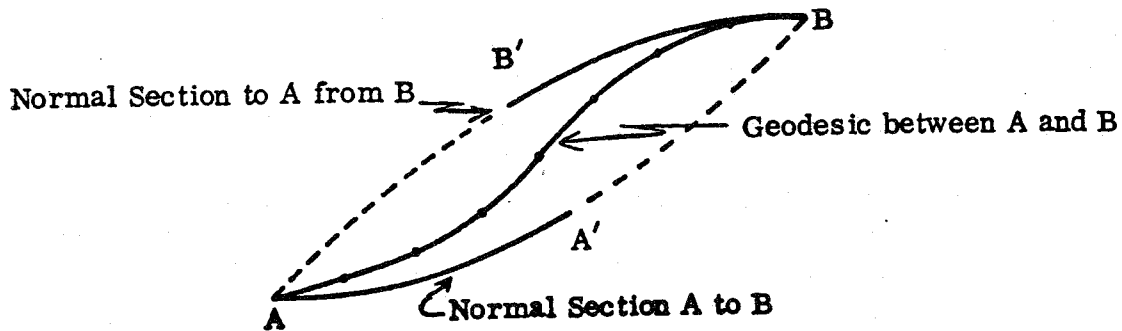

Figure 4.17
The Geodesic Between Two Normal Sections

An example of the relationship of the normal section curves and the geodesic for two points located on a highly flattened ellipsoid is shown in Figure 4.18 from Jordan (Volume III, second half, p. 26).

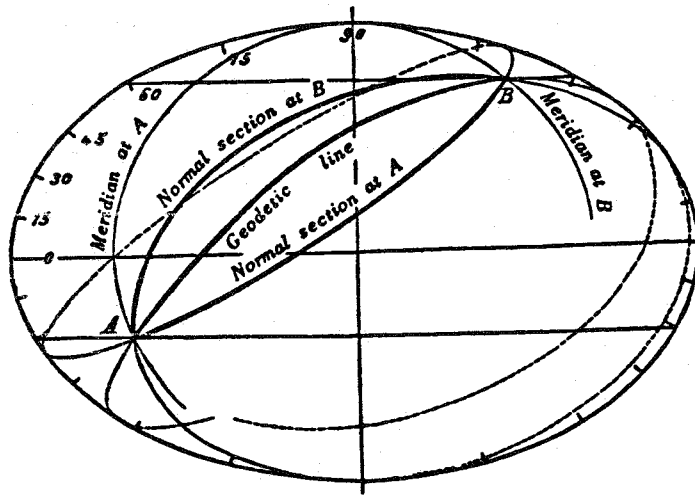

Figure 4.18
A Geodesic and Normal Section on a Highly Flattened ($f=1/3$) Ellipsoid

An important property of the geodesic is clear from its construction definition. This property is that the principal normal of the geodesic at any point will coincide with the ellipsoid normal at the point. The principal normal is contained within the osculating plane which passes through three neighboring points on each curve. It is clear that a normal section does not have this property because each point on the normal section does not contain the normal at the point

To this point, we have considered the geodesic in a geometric interpretation. It is possible to find certain properties of the geodesic by mathematical considerations arising from the definition of the geodesic of being the curve having the shortest distance between any two points.

We now consider a differential triangle on the ellipsoid as shown in Figure 4.19.

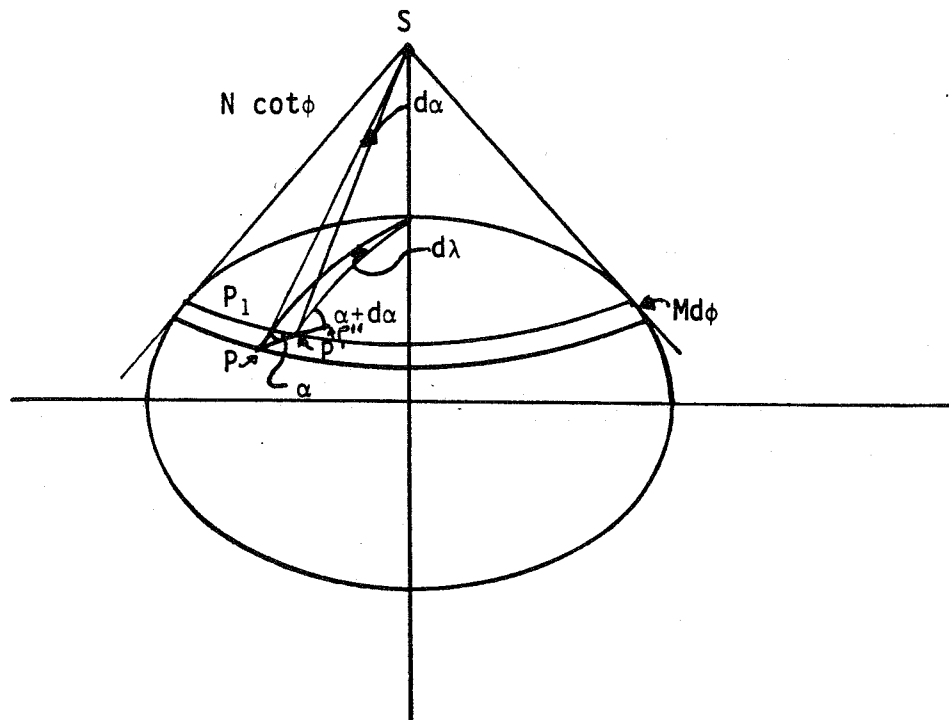

Figure 4.19
A Differential Figure on the Ellipsoid

From the differential right triangle, PP_1P' , we can write:

$$\begin{aligned} ds \cos\alpha &= M d\phi \\ ds \sin\alpha &= N \cos\phi d\lambda \end{aligned} \tag{4.74}$$

Equation (4.74) holds for an arbitrary curve (e.g. normal section or geodesic) on the ellipsoid. Now we specify that PP_1P'' lie on the geodesic. This would be the case if the three points lie in a vertical plane of the ellipsoid passing through P' , which is the osculating plane of the geodesic line at P' (Jordan, volume III, second half, p. 27). In this case we consider the triangle PSP' to find that the angle at S in this triangle is $d\alpha$. We then can write:

$$d\alpha = \frac{N \cos\phi d\lambda}{N \cot\phi} = \sin\phi d\lambda \tag{4.75}$$

Equations (4.74) and (4.75) are the primary differential equations for the geodesic curve on the ellipsoid. Two other equations can also be written. We have:

$$\tan\alpha = \frac{N \cos\phi}{M} \frac{d\lambda}{d\phi} \tag{4.76}$$

$$ds^2 = (M d\phi)^2 + (N \cos\phi d\lambda)^2 \tag{4.77}$$

If we now let $p = N \cos\phi$, and assume that on the geodesic, the longitude is a function of latitude, it is convenient to write equation (4.77) as:

$$\left(\frac{ds}{d\phi}\right)^2 = M^2 + p^2 \left(\frac{d\lambda}{d\phi}\right)^2 \tag{4.78}$$

or solving for ds :

$$\begin{aligned} ds &= [M^2 d\phi^2 + p^2 d\lambda^2]^{\frac{1}{2}} \\ &= \left[M \left(\frac{d\phi}{d\lambda}\right)^2 + p^2 \right]^{\frac{1}{2}} d\lambda \end{aligned} \tag{4.79}$$

If we let $v = [M^2 \left(\frac{d\phi}{d\lambda}\right)^2 + p^2]^{\frac{1}{2}}$ we can write:

$$ds = v d\lambda$$

which we integrate to form:

$$s = \int \rho d\lambda \quad (4.80)$$

For the curve defined by equation (4.80) to be a geodesic, the value of the integral must be a minimum. This turns out to be a calculus of variation problem which is solved in Bagratuni (1967, p. 83) and Jordan (Volume III, second half, p. 30).

After manipulation of equation (4.80), subject to a minimum distance criteria, it is found that the given curve or specifically, the geodesic must satisfy the following equation:

$$p \sin\alpha = \text{constant} \quad (4.81)$$

Thus, the product of the parallel radius times the sine of the geodesic azimuth, at each point on the geodesic is a constant. This equation is known as Clairaut's equation.

An alternate proof to (4.81) can be constructed by starting with the length of the parallel radius p :

$$p = N \cos\phi \quad (4.82)$$

We differentiate this:

$$dp = -N \sin\phi d\phi + \cos\phi dN$$

Since

$$N = \frac{c}{V}$$

we have

$$\frac{dN}{d\phi} = \frac{-c}{V^2} \frac{dV}{d\phi}$$

But

$$\frac{dV}{d\phi} = \frac{-n^2 t}{V}$$

so that

$$dp = \frac{-N \sin\phi}{V^2} d\phi \quad (4.83)$$

Since $N = MV^2$ (4.83) reduces to

$$dp = -M \sin\phi d\phi \quad (4.84)$$

For the geodesic we saw that $d\alpha = \sin\phi d\lambda$ which can be written as:

$$d\alpha = \frac{M \sin\phi d\phi}{Md\phi} d\lambda$$

Using (4.84) we have:

$$d\alpha = \frac{-dp}{Md\phi} d\lambda = \frac{-dp}{\cos\alpha} \frac{d\lambda}{ds}$$

Using the second equation of (4.74) we can write:

$$d\alpha = -\frac{\sin\alpha}{\cos\alpha} \frac{dp}{p}$$

which takes the form:

$$p \cos\alpha d\alpha + \sin\alpha dp = 0$$

which implies

$$p \sin\alpha = \text{constant}$$

which is the same as (4.81)

If we consider many points in a geodesic it follows from (4.81)

$$p_1 \sin\alpha_1 = p_2 \sin\alpha_2 = p_3 \sin\alpha_3 = \dots = \text{a constant} = k \quad (4.85)$$

In order to find the constant involved in (4.85), we can examine the geodesic at two specific points. At the equator $p = a$ and we let the azimuth of the geodesic at the equator be α_E . Then:

$$a \sin \alpha_E = k \quad (4.86)$$

Since p is a maximum at the equator, the sine of the azimuth α_E at the equator will be at its smallest.

The maximum value of $\sin \alpha$ will be one when α equals 90° . This will correspond to the smallest value of the parallel radius, p_{\min} . From equation (4.85) we write:

$$p_{\min} \sin 90^\circ = k$$

or (4.87)

$$p_{\min} = k$$

Clearly p_{\min} occurs at the highest (or maximum) latitude reached by the geodesic of interest.

If we had written in equation (4.81) $p = a \cos \beta$, we would have:

$$a \cos \beta_1 \sin \alpha_1 = a \cos \beta_2 \sin \alpha_2 = \dots = k \quad (4.88)$$

From this equation we have:

$$\cos \beta_1 \sin \alpha_1 = \cos \beta_2 \sin \alpha_2 = \dots = a \text{ constant} = \frac{k}{a} \quad (4.89)$$

Thus the product of the reduced latitude and the geodesic azimuth is a constant at every point in the geodesic. At the equator β equals 0° so that we have:

$$\sin \alpha_E = \frac{k}{a} \quad (4.90)$$

At the maximum latitude reached (ϕ_H or β_H) by the geodesic $\alpha = 90^\circ$ and we have from ((4.89):

$$\cos \beta_H = \frac{k}{a} \quad (4.91)$$

Equating equations (4.90) and (4.91) we find:

$$\sin \alpha_E = \cos \beta_H \quad (4.92)$$

Thus we see that the maximum reduced latitude reached by a geodesic is equal to 90° minus the azimuth of the geodesic at the equator.

We conclude the discussion concerning the general behavior of a geodesic as it goes around the ellipsoid. Such a geodesic is shown in Figure 4.20 where the azimuth of the geodesic is α_E .

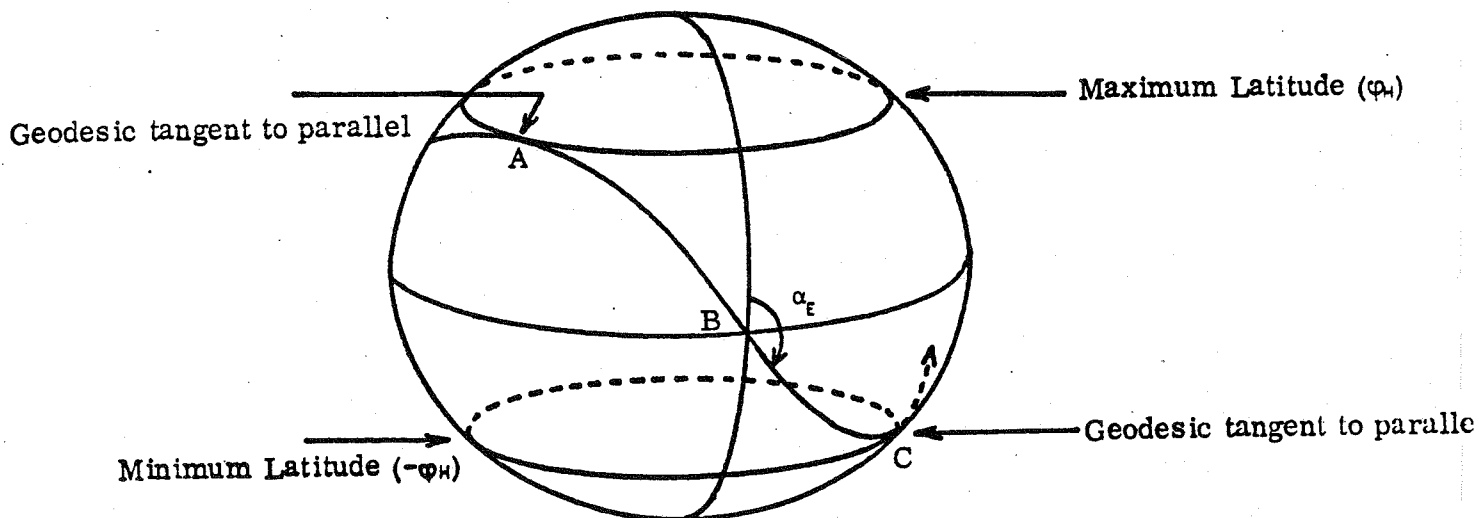

Figure 4.20
The Geodesic in a Continuous Form

As the geodesic goes from A to B to C, its azimuth will continually change. As point C is passed, the geodesic will go past the equator on its way to be tangent to the parallel ϕ_H . Of specific interest is the fact that the equator crossing, after passing through point C will not be exactly 180° in longitude from the crossing point B, but at some point B' generally to the west of B. Thus with but a few exceptions to be discussed in detail later, a geodesic does not repeat its path. There is thus an infinite number of different equator crossings for an arbitrary geodesic. A view of such crossings is seen in Figure 4.21 from Lewis (1963).

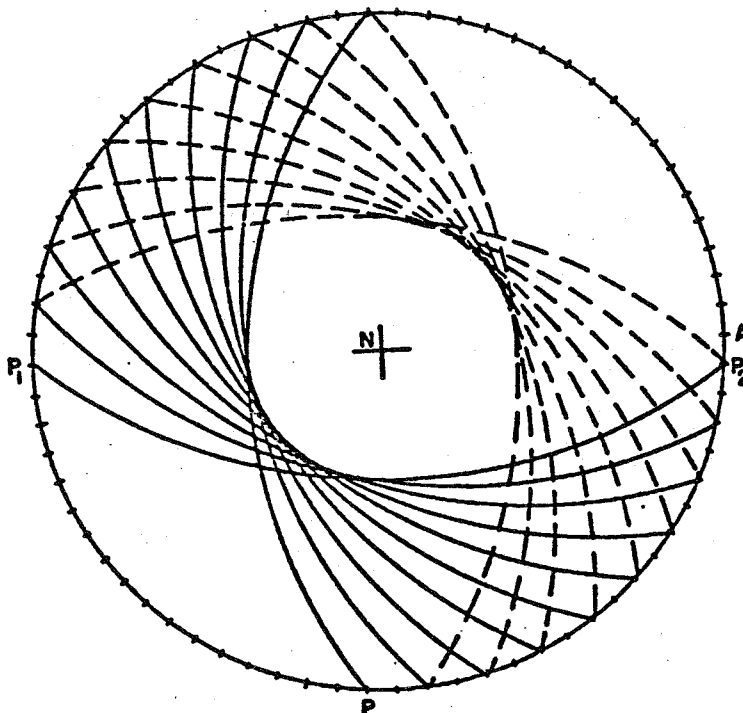

Figure 4.21
A View of a Continuous Geodesic from the North Pole
Showing Consecutive Equator Crossings

4.21 Local x,y,z Coordinates in Terms of the Geodesic

We re-write the equation of the ellipsoid (3.158) using the following notation:

$$\begin{aligned} A &= 1 + e'^2 \cos^2 \phi = 1 + D \\ B &= 1 + e'^2 \sin^2 \phi = 1 + D' \\ C &= -\frac{1}{2} e'^2 \sin 2\phi \end{aligned} \quad (4.93)$$

We have, for the equation of the ellipsoid, (Tobey, 1928):

$$u = 0 = Ax^2 + y^2 + Bz^2 + 2Cxz - 2Nz \quad (4.94)$$

where $x = x(s)$, $y = y(s)$, $z = z(s)$ where s is the geodesic distance.

Now consider a small portion of the surface of the ellipsoid containing a differential portion of the geodesic as shown in Figure 4.22 (Tobey, 1928):

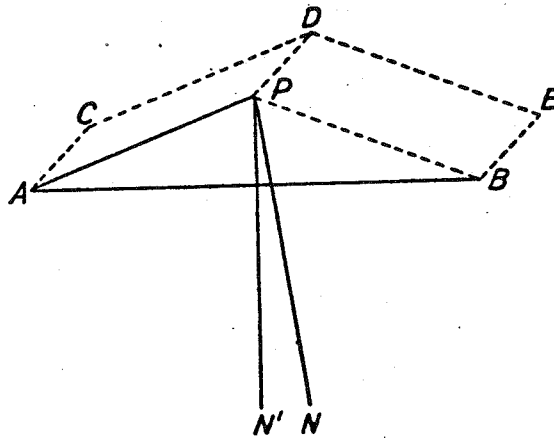

Figure 4.22

The Ellipsoid Surface Containing a Differential Element of the Ellipsoid

We let PACD and PBED be portions of the surface $u = 0$. Let $PA = PB = ds$ be a portion of the geodesic. PN , a line perpendicular to AB , is the principal normal.

At any point on the geodesic the osculating plane of the curve contains the normal to the surface so that the principal normal of the curve coincides with the normal to the surface. This statement can be expressed by writing:

$$\frac{\frac{d^2x}{ds^2}}{\frac{du}{dx}} = \frac{\frac{d^2y}{ds^2}}{\frac{du}{dy}} = \frac{\frac{d^2z}{ds^2}}{\frac{du}{dz}} \quad (4.95)$$

To apply this equation we assume a power series in s for x, y, z :

$$\begin{aligned}x &= \ell_1 s + \ell_2 s^2 + \ell_3 s^3 + \ell_4 s^4 + \dots \\y &= m_1 s + m_2 s^2 + m_3 s^3 + m_4 s^4 + \dots \\z &= n_1 s + n_2 s^2 + n_3 s^3 + n_4 s^4 + \dots\end{aligned}\tag{4.96}$$

We now substitute (4.96) into (4.94) to get an n th degree equation in s . Since the whole equation is equal to zero, the individual coefficients of s must be zero. This result will imply $n_1 = 0$. Next we need to implement the condition (4.95). We first compute the derivatives in the denominator of (4.95) from (4.94):

$$\begin{aligned}\frac{du}{dx} &= 2(Ax + Cz) \\ \frac{du}{dy} &= 2y \\ \frac{du}{dz} &= 2(Bz + Cx - N)\end{aligned}\tag{4.97}$$

The derivatives needed in the numerator are found by differentiation of (4.96)

$$\begin{aligned}\frac{d^2x}{ds^2} &= 1 \cdot 2\ell_2 + 2 \cdot 3\ell_3 s + 3 \cdot 4\ell_4 s^2 + \dots \\ \frac{d^2y}{ds^2} &= 1 \cdot 2m_2 + 2 \cdot 3m_3 s + 3 \cdot 4m_4 s^2 + \dots \\ \frac{d^2z}{ds^2} &= 1 \cdot 2n_2 + 2 \cdot 3n_3 s + 3 \cdot 4n_4 s^2 + \dots\end{aligned}\tag{4.98}$$

We then substitute (4.97) and (4.98) into (4.95) and equate the coefficients of the common powers of s . After some reduction (Tobey, 1928, Proposition II) we have the following equations:

$$\begin{aligned}x &= \ell N \sin \frac{s}{N} - \frac{D\ell(1+\ell^2)}{6N^2} s^3 - \frac{C}{24N^3} (1+8\ell^2) s^4 + \dots \\ y &= mN \sin \frac{s}{N} - \frac{Dm\ell^2}{6N^2} s^3 - \frac{Cm}{3N^3} s^4 + \dots \\ z &= 2N \sin^2 \frac{s}{2N} + \frac{D\ell^2 s^2}{2N} + \frac{C\ell(1+D\ell^2)}{2N^2} s^3 + \frac{3D' - 6D\ell^2}{24N^3} s^4\end{aligned}\tag{4.99}$$

where

$$\begin{aligned} \ell &= \ell_1 = \cos \alpha \\ m &= m_1 = \sin \alpha \\ N &= a / (1 - e^2 \sin^2 \phi_1)^{1/2} \end{aligned} \quad (4.100)$$

Given a geodesic azimuth (α) and distance s , we can use equation (4.99) to compute the coordinates of the geodesic based on a local system at the starting point. Since these equations are in series form there will be a distance beyond which the equations will not be sufficiently accurate. Similar equations can also be derived for a normal section (Clarke, 1880, p. 118).

4.22 The Length of a Differential Arc of a Rotated Geodesic

Consider a geodesic from point A with a length s and an azimuth α . The endpoint of this line defines a point F. Now rotate the geodesic by an amount $d\alpha$ so that the endpoint is now at D. We let the distance DF be dg_e which is to be determined. Using the local x, y, z coordinate system described in the previous section we have:

$$dg_e^2 = dx^2 + dy^2 + dz^2 \quad (4.101)$$

We can differentiate (4.99) with $d\alpha$ as the variable to find $dx, dy,$ and dz . We can simplify (4.101) by writing:

$$dg_e = w d\alpha \quad (4.102)$$

where w is a quantity to be determined from the derivatives from (4.99). After some reduction (Appendix 1, Tobey, 1928, Proposition IV) we have:

$$w = R_A \sin \frac{s}{R_A} - \frac{R_A C \ell}{3} \left(\frac{s}{R_A} \right)^4 + \dots \quad (4.103)$$

where R_A is the Gaussian mean radius at point A. w is called the reduced length of the geodesic.

4.23 Relationship Between the Geodesic and Chord Length

The chord length, c , between two points on the ellipsoid can be computed from:

$$c^2 = x^2 + y^2 + z^2 \quad (4.104)$$

We can express this in terms of the geodesic length by substituting for x, y, z from (4.99). To compute c from s we have (Appendix 1, Tobey, 1928, Proposition V):

$$c = 2N \sin \frac{s}{2N} \left(1 - \frac{D\ell^2}{12} \left(\frac{s}{N}\right)^2 - \frac{C\ell}{8} \left(\frac{s}{N}\right)^3 + \dots \right) \quad (4.105)$$

where N is the prime vertical radius of curvature at the first point. This series can be inverted to find s as a function of c :

$$s = c \left(1 + \frac{1}{24N^2} c^2 + \frac{D\ell^2}{12N^2} c^2 + \frac{C\ell}{8N^3} c^3 + \dots \right) \quad (4.106)$$

Clarke (1880, p. 108) carries out a derivation analogous to the above where the normal section distance, s' , and the chord distance are related. Without derivation we have:

$$s' = c \left(1 + \frac{c^2}{24R_\alpha^2} \left(1 - 3F \frac{c}{R_\alpha} \right) + \left(\frac{3}{640} + \frac{3}{80} H + \frac{1}{4} F^2 \right) \frac{c^4}{R_\alpha} - \left(\frac{3}{16} FH + \frac{5}{12} F^3 \right) \frac{c^5}{R_\alpha^5} + \dots \right) \quad (4.107)$$

where

$$F = \frac{fh}{1+h^2}; \quad H = \frac{f^2 - h^2}{1+h^2}$$

$$f = \frac{e \sin \phi}{\sqrt{1-e^2}}; \quad h = \frac{e \cos \phi \cos \alpha}{\sqrt{1-e^2}}$$

and R_α is the radius of curvature in the normal section azimuth .

4.24 Comparison of Geodesic with the Normal Section

We shall now consider the angular distance difference between geodesics and normal sections. We first consider azimuth differences starting with Figure 4.23 which shows the normal sections and the geodesic between two arbitrary points, A and B.

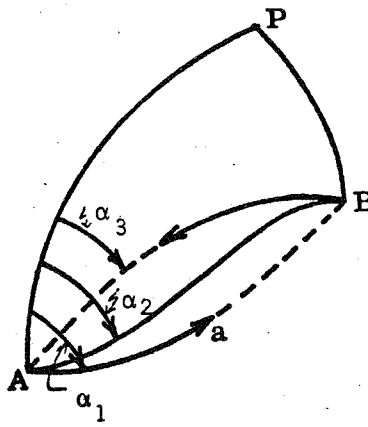

Figure 4.23
The Geodesic Lying Between Two Normal Sections

In this figure:

- α_1 is the azimuth of the normal section, at A, from A to B
- α_2 is the azimuth of the geodesic, at A, from A to B
- α_3 is the azimuth of the normal section, at A, from B to A

The difference $\alpha_1 - \alpha_3$ was computed as Δ and given in equation (4.32) or (4.33). To determine the difference $\alpha_1 - \alpha_2$ we follow Tobey (1928, Proposition VI) which is Appendix 1. We construct in Figure 4.24 a normal section AHFT at point A with azimuth α_1 . AH is tangent to this normal section. AF is the geodesic from A to F that has an azimuth α_2 . The normal section at A, which passes through the point F(x, y, z) (on the ellipsoid) will also pass through the point H(x, y, 0), where H is on the line TF produced.

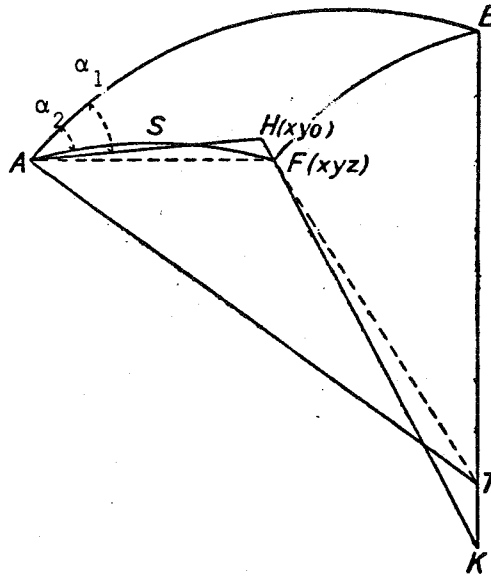

Figure 4.24
Determination of the Azimuth Difference Between
a Normal Section and a Geodesic

The distance AH is:

$$AH^2 = x^2 + y^2 \quad (4.108)$$

which can be found using (4.99)

$$AH = N \sin \frac{s}{N} \left(1 - \frac{D \ell^2}{3} \left(\frac{s}{N} \right)^2 - \frac{3C\ell}{8} \left(\frac{s}{N} \right)^3 + \dots \right) \quad (4.109)$$

Now the normal section azimuth can be determined from:

$$\cos \alpha_1 = \frac{x}{AH} \quad (4.110)$$

Using (4.99) and (4.109), Tobey shows:

$$(\alpha_n - \alpha_g) = (\alpha_1 - \alpha_2) = \left(\frac{D\ell m}{6} \left(\frac{s}{N} \right)^2 + \frac{Cm}{24} \left(\frac{s}{N} \right)^3 + \dots \right) \quad (4.111)$$

If we substitute for C, D, ℓ , m we have

$$(\alpha_1 - \alpha_2) = \frac{n^2}{6} \left(\frac{s}{N} \right)^2 \sin \alpha \cos \alpha - \frac{n^2 t}{24} \left(\frac{s}{N} \right)^3 \sin \alpha \quad (4.112)$$

where:

$$n^2 = e'^2 \cos^2 \phi_A$$

$$t = \tan \phi_A$$

If we consider only the first term of (4.112) we can compare it with (4.32) which gives the azimuth separation of the counter normal sections. We conclude that:

$$(\alpha_1 - \alpha_2) \approx \frac{1}{3} (\alpha_1 - \alpha_3) \quad (4.113)$$

which says that the geodesic approximately trisects the angle between the counter (or reciprocal) normal sections, lying closer to the direct normal section at the given point.

As a numerical estimate of this difference, consider a line of length s located at a mean latitude of 45° and an azimuth of 45° . The value of $(\alpha_1 - \alpha_2)$ is then:

\underline{s}	$(\alpha_1 - \alpha_2)$
30 km	0"001
60	0.005
100	0.014
120	0.020

Although equation (4.113) implies that the geodesic always lies between the two normal sections this is not always true. Consider the case of two points on the same parallel where there is only one normal section. Then the value of Δ in (4.32) is zero so that (4.113) is not correct. In this case the geodesic will be towards the pole side of the normal section and lie completely outside of it. For points not exactly on the same parallel, the geodesic can cross a normal section curve.

In the case of two points on the same meridian there is only one normal section. The geodesic will coincide with this normal section.

4.25 Difference in Length Between the Normal Section and the Geodesic

To derive the length difference $s_n - s_g$ we follow Tobey (1928, Proposition VII). We consider two points A and F that are connected by the normal section of azimuth θ , length s_n and the geodesic of azimuth α and length s_g as shown in Figure 4.25.

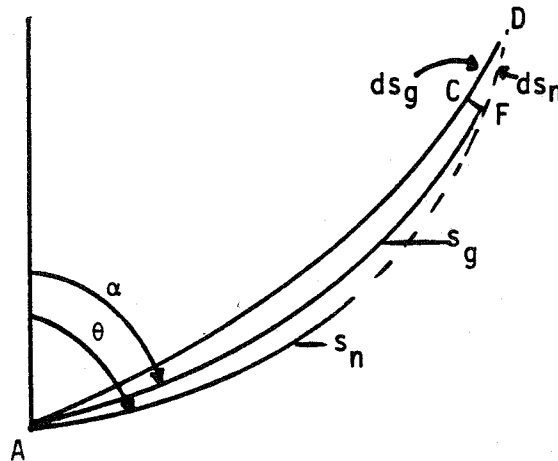

Figure 4.25
Differential Relationship Between Normal Section and Geodesic Lengths

We rotate the geodesic AF about the normal at A, through an angle $d\alpha$, that will yield the arc $d_{ge} = FC$. From (4.102) we have:

$$d_{ge} = w d\alpha \quad (4.114)$$

We now extend the line AC to D (on the normal section AF) by an amount ds_g . This corresponding normal section distance change is ds_n . We then have:

$$FD^2 = DC^2 + CF^2$$

or

$$ds_n^2 = ds_g^2 + (wd\alpha)^2 \quad (4.115)$$

To find $d\alpha$ we differentiate (4.111) with the variables being α_g (or α_2) and ds . We have:

$$d\alpha = \left(\frac{-D\ell m}{3} \left(\frac{s}{N}\right) - \frac{Cm}{8} \left(\frac{s}{N}\right)^2 + \dots \right) \frac{ds_g}{N} \quad (4.116)$$

Recalling the value of w from (4.103) we have:

$$wd\alpha = \left(\frac{-D\ell m}{3} \left(\frac{s}{N}\right)^2 - \frac{Cm}{8} \left(\frac{s}{N}\right)^3 + \dots \right) ds_g \quad (4.117)$$

We now substitute (4.117) into (4.115) to find:

$$ds_n = ds_g \left(1 + \frac{(D\ell m)^2}{18} \left(\frac{s}{N}\right)^4 + \dots \right) \quad (4.118)$$

We integrate this expression to find:

$$s_n = s_g \left(1 + \frac{(D\ell m)^2}{90} \left(\frac{s}{N}\right)^4 + \dots \right) \quad (4.119)$$

Substituting for D , ℓ , and m , and solving for $s_n - s_g$ we have:

$$s_n - s_g = s \frac{e'^4 \cos^4 \phi}{360} \left(\frac{s}{N}\right)^4 \sin^2 2\alpha \quad (4.120)$$

This line length difference is very small due to the presence of the e'^4 and $(s/N)^4$ term. At a distance of 1600 km, this length difference is only 1 mm.

4.3 The Great Elliptic Arc and the Curve of Alignment

Consider two points, A and B, located on the surface of the ellipsoid. The intersection of the plane containing A, B, and the center of the ellipsoid, with the surface of the ellipsoid, is called the great elliptic curve. There clearly is only one great elliptic curve between two points. For such a curve there will be a unique azimuth and distance. The great elliptic curve is hardly used in practice so that little literature exists on this curve. Bowring (1984) has described position computations using this curve.

Another curve that has been described between two points on the surface is the curve of alignment (Clarke, 1880, p. 116, Baeschlin, 1948, section 17). To describe this curve, again consider two points, A and B, on the ellipsoid. Let AB be the normal section from A to B, and BA be the normal section from B to A. Next consider a meridian between the meridians of A and B. The two normal sections will intersect this meridian at Q_1 and Q_2 as shown in Figure 4.26:

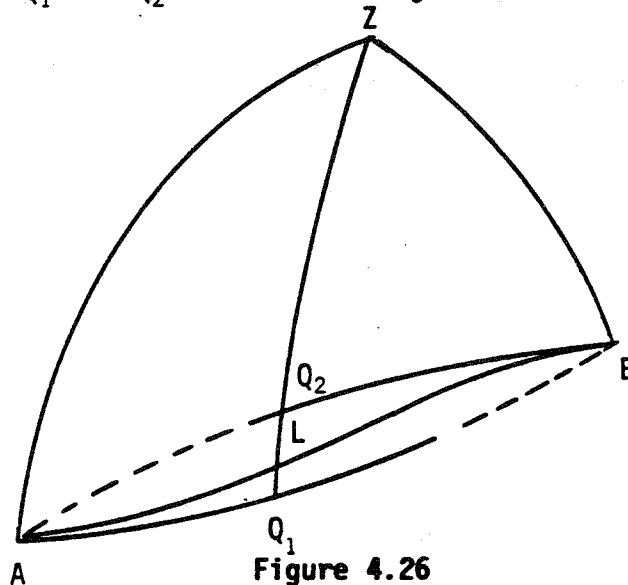

Figure 4.26
The Curve of Alignment

We now define a point L on the meridian ZQ_1Q_2 , such that the azimuth of the sighting to A and to B differ by exactly 180° . If this operation is repeated for all meridians between A and B, the connection of all points L forms the curve of alignment. Because of its construction this curve will be close to the geodesic between the points A and B. As the curve of alignment is not widely used in practice no additional information is given on it.

4.4 Geometric Reduction of Measured Directions or Azimuths

Let D be the observed direction from point A to point B. For certain applications of this data in a triangulation adjustment it

is necessary to apply two corrections based on our previous discussion. In section 4.24 we considered the azimuth difference between the normal section and the geodesic. To convert the normal section direction to the corresponding geodesic direction we add δ_1 to the observed quantity where δ_1 (see equation (4.112)) is:

$$\delta_1 = -\frac{e^2}{12} \left(\frac{s}{N}\right)^2 \cos^2 \phi_m \sin 2\alpha_{AB}$$

If the observed point B is at an elevation h we must add the correction to get the corresponding direction to point B now projected onto the ellipsoid. We let such a correction be δ_2 which is (see equation 4.46):

$$\delta_2 = \frac{h}{2M_m} e^2 \cos^2 \phi_m \sin 2\alpha_{AB} \quad (4.121)$$

5. SOLUTION OF SPHERICAL AND ELLIPSOIDAL TRIANGLES

One of the basic goals of geodesy is the determination of the geodetic coordinates of points referred to a reference ellipsoid. In classical geodetic procedures this is usually done by triangulation and/or trilateration procedures where we measure distance and/or angles or directions to define triangles on the reference ellipsoid. In order to carry out position computations for certain cases it is necessary to develop procedures for solving triangles on the ellipsoid. We first consider the problem by approximating the ellipsoid by a sphere and seeking a solution for spherical triangles. Such triangles are equivalent to ellipsoidal triangles up to sizes of approximately 200 km.

5.1 Spherical Excess

We consider a triangle on the sphere where the three spherical angles are A , B , C . The spherical excess of the triangle is defined as the sum of the three angles minus 180° . Thus:

$$\epsilon = A^\circ + B^\circ + C^\circ - 180^\circ \quad (5.1)$$

This definition arises from the fact that on a plane, the sum of the angles in a plane triangle is 180° exactly.

If R is the radius of the sphere and F is the area of the spherical triangle it can be rigorously shown (Jordan, Volume III, first half, p. 89):

$$\epsilon = \frac{F}{R^2} \quad (5.2)$$

so that spherical excess is proportional to the area of the figure.

If the sides of the triangle are expressed in radian measures as a , b , and c , an alternate expression for spherical excess may be given as (Jordan, Volume III, first half, p. 17):

$$\tan \frac{\epsilon}{4} = \sqrt{\tan \frac{s}{2} \tan \frac{s-a}{2} \tan \frac{s-b}{2} \tan \frac{s-c}{2}} \quad (5.3)$$

where $a + b + c = 2s$.

Examples of the magnitudes of spherical excess are given by Jordan (Volume III, first half, p. 92) as follows:

Area of the Triangle

	<u>ε</u>
1 sq. km	0"00507
21 sq. mile (equilateral triangle with sides of 11 ¼ km)	0"279
200 sq. km (equilateral triangle with sides of 21-½ km)	1"
equilateral triangle with sides of 111 km	27"

5.2 Solution of the Spherical Triangle by Legendre's Theorem

The solution of spherical triangles is simplified if one utilizes Legendre's Theorem which is stated as follows: "If the sides of a plane triangle are equal to the corresponding sides of a spherical triangle, then the angles of the plane triangle will be equal to the corresponding angles of the spherical triangle minus one-third of the spherical excess". This theorem was derived by Legendre in Paris in 1787. In order to prove this theorem we consider a spherical triangle (on a sphere of radius R) and the corresponding plane triangle as shown in Figure 5.1

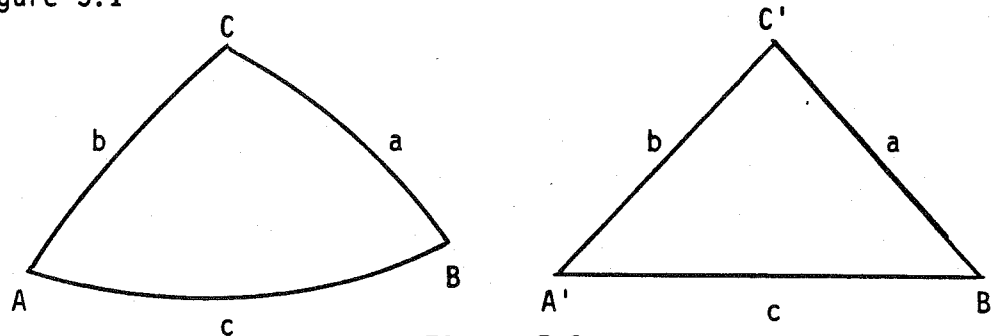

Figure 5.1
Spherical and Planar Triangles

In using these figures we will attempt to find the difference between the angle on the sphere and the angle on the plane, that is (A-A'), (B-B'), (C-C'). To do this we first apply the law of cosines to the spherical triangle to write:

$$\cos \frac{a}{R} = \cos \frac{b}{R} \cos \frac{c}{R} + \sin \frac{b}{R} \sin \frac{c}{R} \cos A \quad (5.4)$$

or

$$\cos A = \frac{\cos \frac{a}{R} - \cos \frac{b}{R} \cos \frac{c}{R}}{\sin \frac{b}{R} \sin \frac{c}{R}} \quad (5.5)$$

Restricting ourselves to small triangles, we note that a/R , b/R and c/R will be small and series expansions for sine or cosine are appropriate. Neglecting the fifth power of a/R , b/R and c/R equation (5.5) may be written as:

$$\cos A = \frac{\left(1 - \frac{a^2}{2R^2} + \frac{a^4}{24R^4}\right) - \left(1 - \frac{b^2}{2R^2} + \frac{b^4}{24R^4}\right) \left(1 - \frac{c^2}{2R^2} + \frac{c^4}{24R^4}\right)}{\left(\frac{b}{R} - \frac{b^3}{6R^3}\right) \left(\frac{c}{R} - \frac{c^3}{6R^3}\right)} \quad (5.6)$$

Multiplying the bracketed terms out, expanding the denominator we find (Jordan, Volume III, first half, p. 94):

$$\cos A = \frac{b^2+c^2-a^2}{2bc} + \frac{a^4+b^4+c^4-2a^2c^2-2b^2c^2-2a^2b^2}{24R^2bc} + \dots \quad (5.7)$$

If we apply the law of cosines in the plane triangle we have:

$$a^2 = b^2 + c^2 - 2bc \cos A' \quad (5.8)$$

which is solved for $\cos A'$ to find:

$$\cos A' = \frac{b^2 + c^2 - a^2}{2bc} \quad (5.9)$$

We may also obtain an expression for $\sin^2 A'$ by solving $\sin^2 A' = 1 - \cos^2 A'$, so that we have from equation (5.9)

$$\sin^2 A' = \frac{-a^4 - b^4 - c^4 + 2a^2b^2 + 2a^2c^2 + 2b^2c^2}{4b^2c^2} \quad (5.10)$$

We note that equation (5.9) represents the first part of equation (5.7) while the equation (5.10) is related to the second part of (5.7). Using (5.10) and (5.09) in equation (5.7) we find:

$$\cos A = \cos A' - \frac{bc \sin^2 A'}{6R^2} + \dots \quad (5.11)$$

We now use (2.23), writing it for $n = 1$ as:

$$\cos x - \cos y = -2 \sin \frac{x-y}{2} \sin \frac{x+y}{2} \quad (5.12)$$

where in our case $x = A$ and $y = A'$. As a sufficient approximation we take:

$$\sin \frac{x-y}{2} = \sin \frac{A-A'}{2} \approx \frac{A-A'}{2} \quad (5.13)$$

$$\sin \frac{x+y}{2} = \sin \frac{A+A'}{2} \approx \sin A'$$

since the difference between A and A' will be small.

Combining equations (5.13), (5.12) with equation (5.11) we have:

$$A-A' = \frac{bc \sin A'}{6R^2} + \dots \quad (5.14)$$

The area of the plane triangle, is $\frac{bc \sin A'}{2}$, so that equation (5.14) is written:

$$A - A' = \frac{P}{3R^2} \quad (5.15)$$

In a similar manner it can be shown that:

$$B - B' = \frac{P}{3R^2} \quad (5.16)$$

$$C - C' = \frac{P}{3R^2}$$

If we add equation (5.15) and (5.16) and note that $(A' + B' + C') = 180^\circ$ we have:

$$A + B + C = 180^\circ + \frac{P}{R^2} \quad (5.17)$$

Comparing this to equation (5.1) or (5.2) it is clear that P/R^2 is essentially the spherical excess of the triangle. Thus equations (5.15) and (5.16) may be written in the form:

$$A - A' = \frac{\epsilon}{3}$$

$$B - B' = \frac{\epsilon}{3} \quad (5.18)$$

$$C - C' = \frac{\epsilon}{3}$$

These equations are the justification for Legendre's theorem.

Equations (5.17) and (5.18) are approximations only. More precise derivations yield the following extended equations (Jordan, Volume III, first half, p. 110):

$$\begin{aligned}(A - A') &= \frac{P}{3R^2} \left[1 + \frac{a^2 + 7b^2 + 7c^2}{120R^2} \right] + \dots \\(B - B') &= \frac{P}{3R^2} \left[1 + \frac{7a^2 + b^2 + 7c^2}{120R^2} \right] + \dots \\(C - C') &= \frac{P}{3R^2} \left[1 + \frac{7a^2 + 7b^2 + c^2}{120R^2} \right] + \dots\end{aligned}\tag{5.19}$$

If we sum these equations we have:

$$A + B + C = 180^\circ + \frac{P}{R^2} \left[1 + \frac{a^2 + b^2 + c^2}{24R^2} \right]\tag{5.20}$$

so that upon comparison with equation (5.1) the spherical excess of the triangle is :

$$\epsilon = \frac{P}{R^2} \left[1 + \frac{a^2 + b^2 + c^2}{24R^2} \right]\tag{5.21}$$

At this point we note that the area, P, of the plane triangle can be rigorously given by:

$$P = \sqrt{s(s-a)(s-b)(s-c)}\tag{5.22}$$

where $s = (a+b+c)/2$.

We next solve for P/R^2 from equation (5.21) and substitute the results in (5.19). We have (Jordan, Volume III, first half, p. 112):

$$\begin{aligned}(A - A') &= \frac{\epsilon}{3} + \frac{\epsilon}{60R^2} (m^2 - a^2) \\(B - B') &= \frac{\epsilon}{3} + \frac{\epsilon}{60R^2} (m^2 - b^2) \\(C - C') &= \frac{\epsilon}{3} + \frac{\epsilon}{60R^2} (m^2 - c^2)\end{aligned}\tag{5.23}$$

where $m^2 = \frac{a^2 + b^2 + c^2}{3}$

Equation (5.23) can be compared to equation (5.18) to see that Legendre's theorem is only an approximation.

For applications in triangles that are not typical of those found in ordinary triangulation it is necessary to derive the Legendre's theorem for triangles on the ellipsoid. In this case we now deal with ellipsoidal excess. A complete derivation can be found in Jordan (Volume III, second half, p. 66).

To summarize the solution we first designate the vertices of the ellipsoidal triangle as A, B, C. At each point, the mean curvature is:

$$K_A = (MN)_A^{-1}; \quad K_B = (MN)_B^{-1}; \quad K_C = (MN)_C^{-1} \quad (5.24)$$

The mean curvature is:

$$K_m = (K_A + K_B + K_C)/3 \quad (5.25)$$

Then the relationship between the ellipsoidal angles and the planar angles is:

$$\begin{aligned} (A - A') &= \frac{\epsilon}{3} + \frac{\epsilon}{60} K_m (m^2 - a^2) + \frac{\epsilon}{12} \frac{K_A - K_m}{K_m} \\ (B - B') &= \frac{\epsilon}{3} + \frac{\epsilon}{60} K_m (m^2 - b^2) + \frac{\epsilon}{12} \frac{K_B - K_m}{K_m} \\ (C - C') &= \frac{\epsilon}{3} + \frac{\epsilon}{60} K_m (m^2 - c^2) + \frac{\epsilon}{12} \frac{K_C - K_m}{K_m} \end{aligned} \quad (5.26)$$

The second terms on the right hand side of (5.26) are the second order spherical terms (equation (5.23)) while the third terms represent the ellipsoidal contributions. The value of ϵ is:

$$\epsilon = P K_m \left(1 + \frac{m^2 K_m}{8} \right) \quad (5.27)$$

The area of the plane triangle can be found from (5.22)

As a numerical example we consider a triangle described in Jordan (Volume III, second half, p. 67) where:

$$\begin{aligned}
 a &= 69194 \text{ m} \\
 b &= 105973 \text{ m} \\
 c &= 84941 \text{ m} \\
 \phi_A &= 50^\circ 51' 9'' \\
 \phi_B &= 51^\circ 28' 31'' \\
 \phi_C &= 51^\circ 48' 2''
 \end{aligned}$$

The ellipsoidal excess of this triangle is 14".850054. The results of the evaluation of (5.26) are as follows:

$$A - A' = 4.950018 + 0.000018 + 0.000148 = 4".950184$$

$$B - B' = 4.950018 - 0.000021 - 0.000028 = 4".949969$$

$$C - C' = 4.950018 + 0.000003 - 0.000120 = 4".949901$$

We note that the corrections due to using the ellipsoidal triangles are larger than the corrections from the higher order spherical term.

5.3 Solution of Spherical Triangles by Additaments

In the solution of triangles by Legendre's method the sides of a triangle were kept fixed while the angles were modified. In the additament method two angles are kept fixed while the side lengths are changed. In order to derive this procedure, one can write the law of sines in the spherical triangle shown in Figure 5.2.

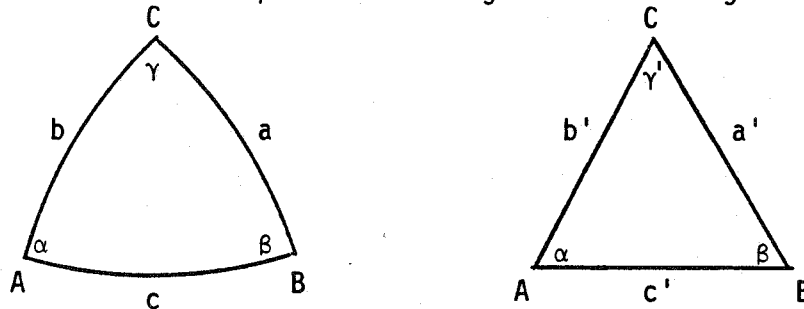

Figure 5.2
Triangles for the Additament Method

$$\frac{\sin A}{\sin B} = \frac{\sin \frac{a}{R}}{\sin \frac{b}{R}} \quad (5.28)$$

while in the corresponding plane triangle (with unchanged angles)

$$\frac{\sin A}{\sin B} = \frac{a'}{b'} \quad (5.29)$$

Equating equations (5.28) and (5.29) we have:

$$\frac{a'}{b'} = \frac{\sin \frac{a}{R}}{\sin \frac{b}{R}} = \frac{\frac{a}{R} - \frac{a^3}{6R^3}}{\frac{b}{R} - \frac{b^3}{6R^3}} = \frac{a - \frac{a^3}{6R^2}}{b - \frac{b^3}{6R^2}} \quad (5.30)$$

where we have retained terms to the third power in (a/R or b/R). We can satisfy this equation if we set:

$$a' = a - \frac{a^3}{6R^2} \quad (5.31)$$

$$b' = b - \frac{b^3}{6R^2}$$

or for an arbitrary side.

$$s' = s - \frac{s^3}{6R^2} \quad (5.32)$$

The value of $s^3/6R^2$ is called the linear additament for side s. For various s values this correction is approximately as follows: ($\phi_m = 50^\circ$):

<u>s (km)</u>	<u>$\frac{s^3}{6R^2}$ (m)</u>
10	.004
20	.033
30	.111
40	.262
50	.512
60	.884
80	2.096
100	4.093

The use of additaments was primarily in a logarithmic form as shown in Jordan (Volume III, first half, p. 98). Since this procedure is not extensively used now, we do not examine this method in further detail at this time.

6. CALCULATION OF GEODETIC COORDINATES (SOLUTIONS OF THE ELLIPSOIDAL POLAR TRIANGLE)

6.1 Introduction

We next look at the computation of the geodetic coordinates of points on the ellipsoid. Such coordinates are usually specified as latitude and longitude. If we assume that we are given the coordinates of a starting point, a distance and azimuth to a second point, we desire to compute the coordinates of the second point, as well as the azimuth from the second point to the first. Such a problem is defined as the direct geodetic problem or simply the direct problem.

The inverse geodetic problem is defined as the case where the coordinates of the end points of the line are given and we desire to find the azimuth from point one to point two, the azimuth from point two to point one, and the distance between the two points.

The solution of either of these problems is basically a solution of the ellipsoidal polar triangle shown in Figure 6.1.

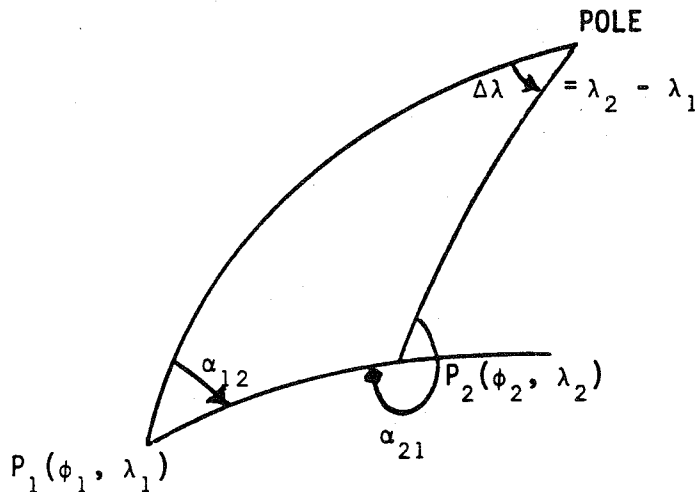

Figure 6.1
The Polar Ellipsoidal Triangle

We can express the previously defined problems in the following functional form:

$$\begin{aligned}
 \text{Direct Problem:} \quad \phi_2 &= f_1(\phi_1, \lambda_1, \alpha_{12}, s) \\
 \lambda_2 &= f_2(\phi_1, \lambda_1, \alpha_{12}, s) \\
 \alpha_{21} &= f_3(\phi_1, \lambda_1, \alpha_{12}, s)
 \end{aligned} \tag{6.1}$$

$$\begin{aligned}
 \text{Inverse Problem:} \quad s &= f_4(\phi_1, \lambda_1, \phi_2, \lambda_2) \\
 \alpha_{12} &= f_5(\phi_1, \lambda_1, \phi_2, \lambda_2) \\
 \alpha_{21} &= f_6(\phi_1, \lambda_1, \phi_2, \lambda_2)
 \end{aligned} \tag{6.2}$$

There are many solutions for these problems. Such solutions are generally classified by the distance for which they are valid and by the type (e.g. normal section or geodesic) of line being considered. We may have simplified solution techniques for short distances while more extensive formulas are needed for long lines. We shall look at equations for short and medium length lines in the next sections.

6.2 Series Development in Powers of s

6.21 The Direct Problem

We assume that a curve on the ellipsoid can be expressed as a function of s:

$$\begin{aligned}\phi &= \phi(s) \\ \lambda &= \lambda(s) \\ \alpha &= \alpha(s)\end{aligned}\tag{6.3}$$

We now develop equations (6.3) into a Maclaurin series about the first point as an origin:

$$\begin{aligned}\phi &= \phi_1 + \left. \frac{d\phi}{ds} \right|_1 s + \left. \frac{d^2\phi}{ds^2} \right|_1 \frac{s^2}{2} + \dots \\ \lambda &= \lambda_1 + \left. \frac{d\lambda}{ds} \right|_1 s + \left. \frac{d^2\lambda}{ds^2} \right|_1 \frac{s^2}{2} + \dots\end{aligned}\tag{6.4}$$

$$\alpha_{21} = \alpha_{12} + 180^\circ + \Delta\alpha = \alpha_{12} + 180^\circ + \left. \left(\frac{d\alpha}{ds} \right) \right|_1 s + \left. \left(\frac{d^2\alpha}{ds^2} \right) \right|_1 \frac{s^2}{2} + \dots$$

α_{12} is the forward azimuth at point 1 while α_{21} is the back azimuth at point 2. We now start the evaluation of the derivatives by recalling equations (4.74) and (4.75):

$$\begin{aligned}ds \cos \alpha &= M d\phi \\ ds \sin \alpha &= N \cos \phi d\lambda \\ d\alpha &= \sin \phi d\lambda\end{aligned}\tag{6.5}$$

We recall that:

$$M = \frac{C}{V^3}, \quad \text{and} \quad N = \frac{C}{V}$$

so that we have from (6.5) after substituting for M and N:

$$\frac{d\phi}{ds} = \frac{1}{c} V^3 \cos\alpha = \frac{\cos\alpha}{M} \quad (6.7)$$

$$\frac{d\lambda}{ds} = \frac{V \sin\alpha}{c \cos\phi} = \frac{\sin\alpha}{N \cos\phi} \quad (6.8)$$

If we solve equation (6.8) for $d\lambda$ and substitute this into $d\alpha = \sin\phi d\lambda$ we have:

$$\frac{d\alpha}{ds} = \frac{V}{c} \sin\alpha \tan\phi \quad (6.9)$$

In order to carry out the differentiation needed in equation (6.4) we will need the derivative of V with respect to ϕ since:

$$\frac{dV}{ds} = \frac{dV}{d\phi} \frac{d\phi}{ds}$$

We have:

$$V = \sqrt{1 + e'^2 \cos^2\phi}$$

$$\frac{dV}{d\phi} = \frac{-e'^2 \sin\phi \cos\phi}{V}$$

Letting: $\eta^2 = e'^2 \cos^2\phi$ and $t = \tan\phi$ we have

$$V^2 = 1 + \eta^2$$

$$\frac{dV}{d\phi} = \frac{-\eta^2 t}{V} \quad (6.10)$$

$$\frac{dV}{ds} = -\eta^2 \frac{V^2}{c} \cos\alpha t$$

In order to find the second derivatives needed in equation (6.4) we first write:

$$\begin{aligned} \frac{d^2\phi}{ds^2} &= \frac{d}{ds} \left[\frac{V^3}{c} \cos\alpha \right] \\ &= \frac{3V^2}{c} \frac{dV}{ds} \cos\alpha - \frac{V^3}{c} \sin\alpha \frac{d\alpha}{ds} \end{aligned}$$

Using equations (6.9) and (6.10) we find:

$$\frac{d^2\phi}{ds^2} = \frac{-V^4}{c^2} (\sin^2\alpha t + 3 \cos^2\alpha n^2 t) \quad (6.11)$$

A compact form for expressing these derivatives can be obtained by letting:

$$v = \frac{s \sin\alpha}{N} = \frac{V s \sin\alpha}{c} \quad (6.12)$$

$$u = \frac{s \cos\alpha}{N} = \frac{V s \cos\alpha}{c}$$

Then the derivatives of ϕ with respect to s are as follows (Jordan, Volume III, second half, p. 77):

$$\begin{aligned} \frac{d\phi}{ds} \frac{s}{V^2} &= +u \\ \frac{d^2\phi}{ds^2} \frac{s^2}{V^2} &= -v^2 t - u^2 (3\eta^2 t) \\ \frac{d^3\phi}{ds^3} \frac{s^3}{V^2} &= -v^2 u (1 + 3t^2 + \eta^2 - 9\eta^2 t^2) - 3u^3 \eta^2 (1 - t^2 + \eta^2 - 5\eta^2 t^2) \\ \frac{d^4\phi}{ds^4} \frac{s^4}{V^2} &= +v^4 t (1 + 3t^2 + \eta^2 - 9\eta^2 t^2) - 2v^2 u^2 t (4 + 6t^2 - 13\eta^2 - 9\eta^2 t^2 - 17\eta^4 \\ &\quad + 45\eta^4 t^2) + u^4 t \eta^2 (12 + 69\eta^2 - 45\eta^2 t^2 + 57\eta^4 - 105\eta^4 t^2) \\ \frac{d^5\phi}{ds^5} \frac{s^5}{V^2} &= +v^4 u (1 + 30t^2 + 45t^4) - 2v^2 u^3 (4 + 30t^2 + 30t^4) \end{aligned} \quad (6.13)$$

In these expressions all terms are retained to the fourth order derivative but all η^n terms in the fifth derivative have been set to zero.

We next consider $\frac{d^2\lambda}{ds^2}$ by differentiating equation (6.8):

$$\frac{d^2\lambda}{ds^2} = \frac{d}{ds} \left[\frac{d\lambda}{ds} \right] = \frac{1}{c} \frac{\sin\alpha}{\cos\phi} \frac{dV}{ds} + \frac{V}{c} \frac{\cos\alpha}{\cos\phi} \frac{d\alpha}{ds} + \frac{V}{c} \frac{\tan\phi}{\cos\phi} \sin\alpha \frac{d\phi}{ds} \quad (6.14)$$

Substituting the value of $\frac{dV}{ds}$ from (6.10), $\frac{d\alpha}{ds}$ from (6.9) and $\frac{d\phi}{ds}$ from (6.7) we have:

$$\frac{d^2\lambda}{ds^2} = \frac{2V^2}{c^2 \cos\phi} \sin\alpha \cos\alpha t = \frac{V^2 t}{c^2 \cos\phi} \sin 2\alpha \quad (6.15)$$

Using the notation of (6.12) the derivatives (to the fifth order) are:

$$\begin{aligned}
 \frac{d\lambda}{ds} s \cos \varphi &= +v \\
 \frac{d^2\lambda}{ds^2} s^2 \cos \varphi &= +2vu t \\
 \frac{d^3\lambda}{ds^3} s^3 \cos \varphi &= +2vu^2(1+3t^2+\eta^2) - 2v^3 t^2 \\
 \frac{d^4\lambda}{ds^4} s^4 \cos \varphi &= 8vu^3 t(2+3t^2+\eta^2-\eta^4) - 8v^3 u t(1+3t^2+\eta^2) \\
 \frac{d^5\lambda}{ds^5} s^5 \cos \varphi &= 8vu^4(2+15t^2+15t^4) - 8v^3 u^2(1+20t^2+30t^4) + 8v^5 t^2(1+3t^2)
 \end{aligned} \tag{6.16}$$

We next differentiate equation (6.9):

$$\frac{d^2\alpha}{ds^2} = \frac{d}{ds} \left[\frac{d\alpha}{ds} \right] = \frac{\sin\alpha}{c} t \frac{dV}{ds} + \frac{V}{c} (1+t^2) \sin\alpha \frac{d\phi}{ds} + \frac{V}{c} \cos\alpha \cdot t \cdot \frac{dA}{ds}$$

Substitution of the appropriate derivatives gives:

$$\frac{d^2\alpha}{ds^2} = \frac{V^2}{c^2} \sin\alpha \cos\alpha (1+2t^2+\eta^2) \tag{6.17}$$

The values of these derivatives to the fifth order are:

$$\begin{aligned}
 \frac{d\alpha}{ds} s &= vt \\
 \frac{d^2\alpha}{ds^2} s^2 &= vu(1+2t^2+\eta^2) \\
 \frac{d^3\alpha}{ds^3} s^3 &= vu^2 t(5+6t^2+\eta^2-4\eta^4) - v^3 t(1+2t^2+\eta^2) \\
 \frac{d^4\alpha}{ds^4} s^4 &= vu^3(5+28t^2+24t^4+6\eta^2+8\eta^2 t^2-3\eta^4+4\eta^4 t^2-4\eta^6+24\eta^6 t^2) \\
 &\quad - v^3 u(1+20t^2+24t^4+2\eta^2+8\eta^2 t^2+\eta^4-12\eta^4 t^2) \\
 \frac{d^5\alpha}{ds^5} s^5 &= vu^4 t(61+180t^2+120t^4) - v^3 u^2 t(58+280t^2+240t^4) \\
 &\quad + v^5 t(1+20t^2+24t^4).
 \end{aligned} \tag{6.18}$$

If we now substitute these derivatives into the general form represented by (6.4) we have the following working equations (Jordan, Volume III, second half, p. 78)

$$\begin{aligned}
\frac{\phi_2 - \phi_1}{V^2} &= u - \frac{1}{2} v^2 t - \frac{3}{2} u^2 n^2 t \\
&- \frac{v^2 u}{6} (1 + 3t^2 + n^2 - 9n^2 t^2) - \frac{u^3}{2} n^2 (1 - t^2) \\
&+ \frac{v^4}{24} t (1 + 3t^2 + n^2 - 9n^2 t^2) - \frac{v^2 u^2}{12} t (4 + 6t^2 - 13n^2 - 9n^2 t^2) \\
&\qquad\qquad\qquad + \frac{u^4}{2} n^2 t \\
&+ \frac{v^4 u}{120} (1 + 30t^2 + 45t^4) - \frac{v^2 u^3}{30} (2 + 15t^2 + 15t^4)
\end{aligned}$$

$$\begin{aligned}
(\lambda_2 - \lambda_1) \cos \phi &= v + vut \\
&- \frac{v^3}{3} t^2 + \frac{vu^2}{3} (1 + 3t^2 + n^2) \\
&- \frac{v^3 u}{3} t (1 + 3t^2 + n^2) + \frac{vu^3}{3} t (2 + 3t^2 + n^2) \qquad (6.19) \\
&+ \frac{v^5}{15} t^2 (1 + 3t^2) + \frac{vu^4}{15} (2 + 15t^2 + 15t^4) - \frac{v^3 u^2}{15} (1 + 20t^2 + 30t^4)
\end{aligned}$$

$$\begin{aligned}
\alpha_{21} - (\alpha_{12} \pm 180^\circ) &= vt + \frac{vu}{2} (1 + 2t^2 + n^2) \\
&- \frac{v^3}{6} t (1 + 2t^2 + n^2) + \frac{vu^2}{6} t (5 + 6t^2 + n^2 - 4n^4) \\
&- \frac{v^3 u}{24} (1 + 20t^2 + 24t^4 + 2n^2 + 8n^2 t^2) + \frac{vu^3}{24} (5 + 28t^2 + 24t^4 \\
&\qquad\qquad\qquad + 6n^2 + 8n^2 t^2) \\
&+ \frac{v^5}{120} t (1 + 20t^2 + 24t^4) - \frac{v^3 u^2}{120} t (58 + 280t^2 + 240t^4) \\
&\qquad\qquad\qquad + \frac{vu^4}{120} t (61 + 180t^2 + 120t^4).
\end{aligned}$$

All angular units in these expressions will be in radians. Also recall that these equations specifically hold for the geodesic line.

The accuracy of the extended question is such that Bagratuni (1967, p. 136) indicates that they can be used up to 130 km. However, Grushinsky (1969, p. 62) indicates that such formulas are useful up to 600-800 km. More detailed accuracy statements will be made later.

6.22 The Inverse Solution

The solution of the inverse problem using series expansions is not as direct as expressed by equation (6.4). We will solve this problem using the first terms of equation (6.19) in an iterative procedure. We can write (6.19) in the form:

$$\phi_2 - \phi_1 = \frac{V_1^3}{C} \cos \alpha_{12} \cdot s + \Delta_A \quad (6.20)$$

$$\lambda_2 - \lambda_1 = \frac{V_1}{C} \frac{\sin \alpha_{12}}{\cos \phi_1} s + \Delta_B$$

where Δ_A and Δ_B are functions of s , α_{12} , and ϕ_1 . We now solve equation (6.20) assuming Δ_A and Δ_B are known. Letting $\Delta\phi = \phi_2 - \phi_1$ and $\Delta\lambda = \lambda_2 - \lambda_1$, we have

$$\begin{aligned} \frac{V_1}{C} \frac{\sin \alpha_{12}}{\cos \phi_1} s &= \Delta\lambda - \Delta_B \\ \frac{V_1^3}{C} \cos \alpha_{12} s &= \Delta\phi - \Delta_A \end{aligned} \quad (6.21)$$

Dividing these two equations and rearranging terms we have:

$$\tan \alpha_{12} = V_1^2 \cos \phi_1 \left[\frac{\Delta\lambda - \Delta_B}{\Delta\phi - \Delta_A} \right] \quad (6.22)$$

In addition, s can be found from either of the equations given in (6.21). For example, for the second expression:

$$s = \frac{C(\Delta\phi - \Delta_A)}{V_1^3 \cos \alpha_{12}} \quad (6.23)$$

Knowing $\Delta\lambda$, $\Delta\phi$, and ϕ_1 , and setting Δ_A and Δ_B to zero as a first approximation to the azimuth ($\alpha_{12}^{(1)}$) we have from equation (6.22):

$$\tan \alpha_{12}^{(1)} = V_1^2 \cos \phi_1 \left[\frac{\Delta\lambda}{\Delta\phi} \right] \quad (6.24)$$

Again setting Δ_A equal to zero, now in equation (6.23), and using the azimuth from (6.24), we compute the first approximation to the distance as:

$$s^{(1)} = \frac{C \Delta \phi}{V_1^3 \cos \alpha_{12}^{(1)}} \quad (6.25)$$

Using the now known values of $\alpha_{12}^{(1)}$ and $s^{(1)}$ we can compute values for Δ_A and Δ_B which can then be used in equation (6.22) and (6.23) to find better values for α_{12} and s . The process is iterated until the values of α_{12} and s do not change beyond a specified amount.

6.3 The Puissant Formulas

These equations were originally derived by Puissant in the 18th century. They have been extended and used by a number of different geodetic organizations for their position computation work. These equations are not derived with great rigor and are not usually used for lines greater than 100 km in length.

6.31 The Direct Problem

To derive the necessary equations for the direct problem we consider a sphere of radius N_1 , tangent along the parallel through the first point. For short distances the sphere will be approximately coincident with the second point. We will assume that the azimuth and distance are the same on the sphere and on the ellipsoid. This information is shown in Figure 6.2.

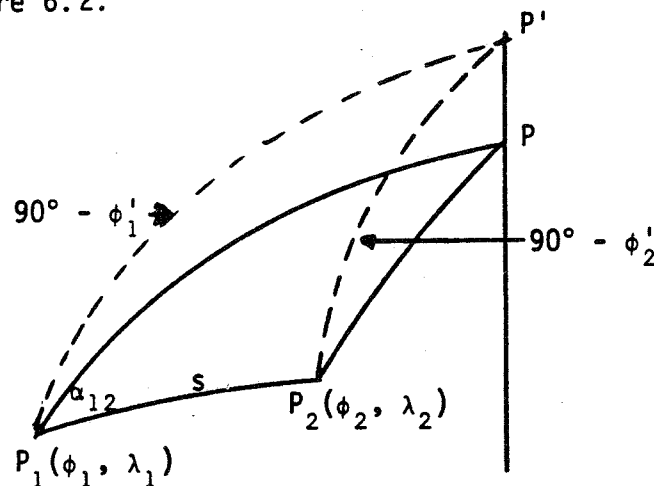

Figure 6.2
The Puissant Approximation for Latitude Determination

$90 - \phi_1'$ and $90 - \phi_2'$ are arcs on a sphere of radius N_1 , tangent at point one. In measuring these arcs we have $\phi_1' = \phi_1$, since the sphere is tangent at the first point. From the spherical triangle $P_1P'P_2$ we write the law of cosines:

$$\sin \phi_2' = \sin \phi_1 \cos \widehat{P_1P_2} + \cos \phi_1 \sin \widehat{P_1P_2} \cos \alpha_{12} \quad (6.26)$$

Since we are dealing with short distances we let $\phi_2' = \phi_1 + \Delta\phi'$ where $\Delta\phi'$ is a small quantity in radians. In addition we let the arc P_1P_2 be given as s/N_1 . Equation (6.26) now becomes:

$$\sin(\phi_1 + \Delta\phi') = \sin\phi_1 \cos \frac{s}{N_1} + \cos\phi_1 \sin \frac{s}{N_1} \cos \alpha_{12} \quad (6.27)$$

We now expand $\sin(\phi_1 + \Delta\phi')$ into a series:

$$\sin(\phi_1 + \Delta\phi') = \sin\phi_1 + \cos\phi_1 \Delta\phi' - \sin\phi_1 \frac{\Delta\phi'^2}{2} - \cos\phi_1 \frac{\Delta\phi'^3}{6} + \quad (6.28)$$

Recognizing that s/N_1 is small we write:

$$\sin \frac{s}{N_1} = \frac{s}{N_1} - \frac{s^3}{6N_1^3} \quad (6.29)$$

$$\cos \frac{s}{N_1} = 1 - \frac{s^2}{2N_1^2}$$

We may substitute equation (6.28) and (6.29) into (6.27) and solve for $\Delta\phi'$. We find:

$$\Delta\phi' = \frac{s}{N_1} \cos\alpha_{12} - \frac{s^2}{2N_1^2} \tan\phi_1 - \frac{s^3}{6N_1^3} \cos\alpha_{12} + \frac{\Delta\phi'^2}{2} \tan\phi_1 + \frac{\Delta\phi'^3}{6} \quad (6.30)$$

Since $\Delta\phi'$ appears on the right side of equation (6.30) we must solve the equation by successive approximations. On the first approximation we take $\Delta\phi' = s \cos\alpha_{12}/N_1$ so that (6.30) now becomes:

$$\Delta\phi' = \frac{s}{N_1} \cos\alpha_{12} - \frac{s^2}{2N_1^2} \tan\phi_1 \sin^2\alpha_{12} - \frac{s^3}{6N_1^3} \cos\alpha_{12} + \frac{\Delta\phi'^3}{6} \quad (6.31)$$

Thus, a better approximation to $\Delta\phi'$ is:

$$\Delta\phi' = \frac{s}{N_1} \cos\alpha_{12} - \frac{s^2}{2N_1^2} \tan\phi_1 \sin^2\alpha_{12} \quad (6.32)$$

Equation (6.32) may now be substituted back into equation (6.30) to find:

$$\Delta\phi' = \frac{s}{N_1} \cos\alpha_{12} - \frac{s^2}{2N_1^2} \sin^2\alpha_{12} \tan\phi_1 - \frac{s^3}{6N_1^3} \cos\alpha_{12} \sin^2\alpha_{12} (1+3\tan^2\phi_1) \quad (6.33)$$

Now we must change $\Delta\phi'$ (measured on the sphere of radius N_1) to $\Delta\phi$ which is measured along an arc of the meridian. To do this we assume the distance $N_1\Delta\phi'$ on the sphere is equal to the corresponding distance on the ellipsoid. Letting M_m be the meridian radius of curvature at the mean latitude we have:

$$N_1\Delta\phi' = M_m\Delta\phi \quad (6.34)$$

which may be solved to find $\Delta\phi$ if we can find M_m . In order to evaluate M_m we need to know the latitude of the second point which is what we are trying to find. To solve the problem we find M_m by an expansion of M about the first point. Thus:

$$M_m = M_1 + \left. \frac{dM}{d\phi} \right|_1 \frac{\Delta\phi}{2} + \dots \quad (6.35)$$

or upon differentiation:

$$M_m = M_1 + \frac{3}{2} \frac{M_1 e^2 \sin\phi_1 \cos\phi_1}{(1 - e^2 \sin^2\phi_1)} \Delta\phi \quad (6.36)$$

Solving (6.34) for $\Delta\phi$ and substituting (6.36) into this expression we have:

$$\Delta\phi = \delta\phi - c\delta\phi\Delta\phi \quad (6.37)$$

where

$$\delta\phi = \frac{s}{M_1} \cos\alpha_{12} - \frac{s^2}{2N_1 M_1} \sin^2\alpha_{12} \tan\phi_1 - \frac{s^3}{6N_1^2 M_1} \sin^2\alpha_{12} \cos\alpha_{12} (1 + 3\tan^2\phi_1) \quad (6.38)$$

and

$$c = \frac{3}{2} \frac{e^2 \sin\phi_1 \cos\phi_1}{(1 - e^2 \sin^2\phi_1)} \quad (6.39)$$

Since $(\delta\phi - \Delta\phi)$ is small, we can let $\delta\phi\Delta\phi$ appearing in equation (6.37) be: $(\delta\phi)^2$. With this substitution and introducing the following symbols (Hosmer, 1930, p. 212):

$$B = \frac{1}{M_1}, \quad C = \frac{\tan \phi_1}{2M_1 N_1}, \quad D = \frac{3e^2 \sin \phi_1 \cos \phi_1}{2(1-e^2 \sin^2 \phi_1)}, \quad (6.39A)$$

$$E = \frac{1 + 3 \tan^2 \phi_1}{6N_1^2}, \quad h = \frac{s \cos \alpha_{12}}{M_1}$$

we have:

$$\Delta \phi = s \cos \alpha_{12} B - s^2 \sin^2 \alpha_{12} C - h s^2 \sin^2 \alpha_{12} E - (\delta \phi)^2 D \quad (6.40)$$

where $\delta \phi$ is given by equation (6.38) or by the sum of the first three terms in equation (6.40). The latitude of the second point will then be $\phi_2 = \phi_1 + \Delta \phi$.

In order to determine the longitude of the second point we define a sphere of radius N_2 tangent to the parallel through P_2 . We assume that this sphere passes close to the first point, so that the azimuth and distance on the ellipsoid and the sphere are the same. This situation is shown in Figure 6.3.

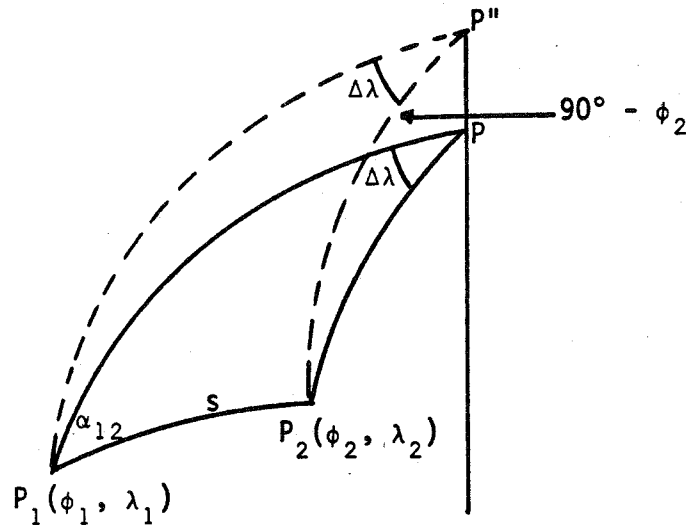

Figure 6.3
The Puissant Approximation for Longitude Determination

Applying the law of sines to the spherical triangle P_1P_2P'' we have:

$$\frac{\sin \Delta \lambda}{\sin \frac{s}{N_2}} = \frac{\sin \alpha_{12}}{\cos \phi_2}$$

so that:

$$\sin \Delta \lambda = \sin \left(\frac{S}{N_2} \right) \sin \alpha_{12} \sec \phi_2 \quad (6.41)$$

Equation (6.41) is a closed expression for an approximate result. The longitude of the second point would be $\lambda_2 = \lambda_1 + \Delta \lambda$. Equation (6.41) may also be developed into the following series form (Clark, 1957, Volume II, p. 336).

$$\Delta \lambda = \frac{S}{N_2} \sin \alpha_{12} \sec \phi_2 \left[1 - \frac{S^2}{6N_2^2} (1 - \sin^2 \alpha_{12} \sec^2 \phi_2) \right] \quad (6.42)$$

We should note that before equations (6.41) or (6.42) are applied, it is necessary to compute the latitude of the second point using equation (6.40). In order to compute the back azimuth, we apply the following equation obtained from Napier's analogies:

$$\tan \frac{1}{2} (B+C) = \frac{\cos \frac{1}{2} (b-c)}{\cos \frac{1}{2} (b+c)} \cot \frac{A}{2} \quad (6.43)$$

where we have by analogy with the Figure 6.1:

$$\begin{aligned} B &= \alpha_{12} & b &= 90^\circ - \phi_2' \\ C &= 360^\circ - \alpha_{21} & c &= 90^\circ - \phi_1 \\ A &= \Delta \lambda \end{aligned} \quad (6.44)$$

which may be put into equation (6.43) to yield:

$$\tan \frac{1}{2} (\alpha_{12} + 360^\circ - \alpha_{21}) = \cot \frac{\Delta \lambda}{2} \frac{\cos \frac{1}{2} [(90 - \phi_2') - (90 - \phi_1)]}{\cos \frac{1}{2} [(90 - \phi_2') + (90 - \phi_1)]} \quad (6.45)$$

We write $\alpha_{21} = \alpha_{12} + \Delta \alpha \pm 180^\circ$ so that equation (6.45) becomes (after inverting):

$$\tan \frac{\Delta \alpha}{2} = \frac{\sin \frac{1}{2} (\phi_1 + \phi_2')}{\cos \frac{\Delta \phi'}{2}} \tan \frac{\Delta \lambda}{2} \quad (6.46)$$

Since $\phi_2' \approx \phi_2$, and $\Delta \phi' \approx \Delta \phi$, equation (6.46) can be written as:

$$\tan \frac{\Delta \alpha}{2} = \frac{\sin \phi_m}{\cos \frac{\Delta \phi}{2}} \tan \frac{\Delta \lambda}{2} \quad (6.47)$$

Equation (6.47) may be put into series form as follows (Clark, 1957, Volume II, p. 337):

$$\Delta\alpha = \Delta\lambda \sin\phi_m \sec \frac{\Delta\phi}{2} + \frac{\Delta\lambda^3}{12} (\sin\phi_m \sec \frac{\Delta\phi}{2} - \sin^3\phi_m \sec^3 \frac{\Delta\phi}{2}) \quad (6.48)$$

Equations (6.40), (6.41), and (6.42) (or equivalent series forms for the latter two) constitute a usual implementation of the Puissant equations. They have been used for distance to the order of 100 km. An additional term to be added to the right hand side of (6.40) extends the accuracy of the procedure to lines of somewhat greater extent. This term is (Hosmer, 1930, p. 219):

$$\frac{1}{2}s^2 kE - \frac{3}{2}s^2 \cos^2\alpha kE - \frac{1}{2}s^2 \cos^2\alpha \sec^2\phi A k \quad (6.49)$$

where $k = s^2 \sin^2\alpha C$ (6.50)

$$A = 1/N_1$$

If short lines (up to approximately 12 miles or 19 km) are being computed, simplified versions of the Puissant equations may be given. From equation (6.40) we could write:

$$\Delta\phi = s \cos\alpha_{12} \cdot B - s^2 \sin^2\alpha_{12} \cdot C - (\delta\phi)^2 D \quad (6.51)$$

From equation (6.42) we would write:

$$\Delta\lambda = \frac{s}{N_2} \sin\alpha_{12} \sec\phi_2 \quad (6.52)$$

and from equation (6.48) we have:

$$\Delta\alpha = \Delta\lambda \sin\phi_m \quad (6.53)$$

6.32 The Inverse Problem

In order to solve the inverse problem using the Puissant equations, we first solve equation (6.42) in the following form:

$$s \sin\alpha_{12} = \frac{N_2 \Delta\lambda \cos\phi_2}{\left[1 - \frac{s^2}{6N_2^2} (1 - \sin^2\alpha_{12} \sec^2\phi_2)\right]} \quad (6.54)$$

If, as a first approximation we set the denominator to one, we can compute $s \sin \alpha_{12}$. We next solve equation (6.40) for $s \cos \alpha_{12}$:

$$s \cos \alpha_{12} = \frac{1}{B} [\Delta\phi + s^2 \sin^2 \alpha_{12} \cdot C + hEs^2 \sin^2 \alpha_{12} + (\delta\phi)^2 D] \quad (6.55)$$

Although we do not know h on the right hand side of the equation, we can find a good approximation to $s \cos \alpha_{12}$. Then

$$\tan \alpha_{12} = \frac{s \sin \alpha_{12}}{s \cos \alpha_{12}} ; s = ((s \sin \alpha_{12})^2 + (s \cos \alpha_{12})^2)^{1/2} \quad (6.56)$$

from which we can find α_{12} and s . Iteration will be necessary to achieve accuracy compatible with that of the direct problem.

We should note that the derivation of the Puissant equations is such that we can not state whether the method is for a geodesic or a normal section. This is immaterial, however, since the application of the Puissant formulas is limited to line lengths where the difference between geodesic and normal section curves is not significant.

6.4 The Gauss Mid-Latitude Formulas

The equations of Puissant are convenient for the solution of the direct problem but they are less convenient when solving the inverse problem. To avoid such a problem it is appropriate to consider the Gauss-mid-latitude formulas (Lambert and Swick, 1935, Lauf, 1983). In this procedure we replace the ellipsoidal polar triangle by a spherical triangle on a sphere having for its radius the prime vertical radius of curvature at the mean latitude between the points. The ellipsoidal triangle $P_1 P_2 P$ and the corresponding spherical triangle $P'_1 P'_2 P'$ are shown in Figure 6.4.

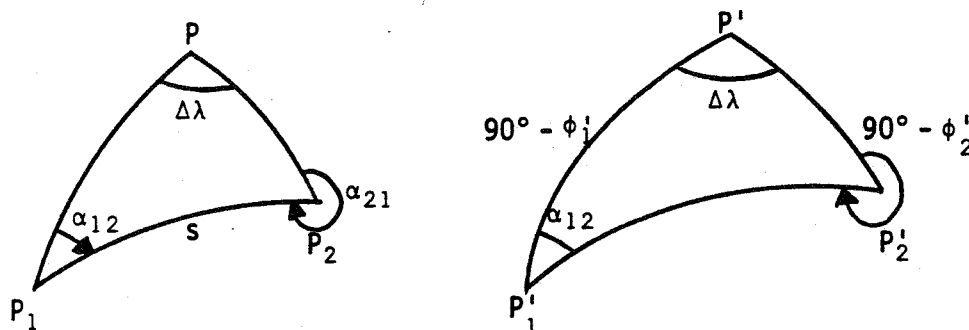

Figure 6.4
Polar Triangles Solved through the Gauss-Mid-Latitude Formulas

We assume that the azimuths and distance on the ellipsoidal and spherical triangles are equal. However, we note that ϕ_1' and ϕ_2' are not equal to ϕ_1 and ϕ_2 because the quantities are being measured with respect to different surfaces. We shall assume that:

$$\phi_m = \frac{1}{2} (\phi_1 + \phi_2) = \frac{1}{2} (\phi_1' + \phi_2') \quad (6.57)$$

We shall also assume that the distance on the arc between the parallels ϕ_1' and ϕ_2' on the sphere is equal to the distance between the parallels ϕ_1 and ϕ_2 on the ellipsoid. Knowing the radius of the sphere is N_m and, with sufficient accuracy the meridian radius of curvature on the ellipsoid is M_m , we can write:

$$N_m(\phi_2' - \phi_1') = M_m(\phi_2 - \phi_1) = M_m \Delta\phi \quad (6.58)$$

This equation is similar to equation (6.34) utilized in the derivation of the Puissant equations. We now utilize the Gauss' or (Delambre) equations written down for the following spherical triangle:

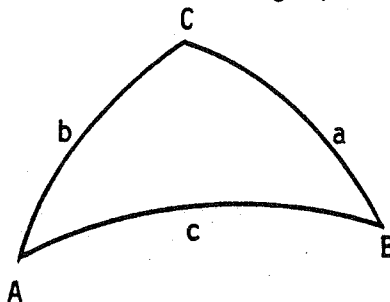

We have:

$$\sin \frac{C}{2} \cos \frac{1}{2} (A - B) = \sin \frac{1}{2} (a + b) \sin \frac{C}{2} \quad (6.59)$$

$$\sin \frac{C}{2} \sin \frac{1}{2} (A - B) = \sin \frac{1}{2} (a - b) \cos \frac{C}{2}$$

In our case we have:

$$c = \frac{S}{N_m}, \quad C = \Delta\lambda$$

$$A = \alpha_{12}, \quad a = 90^\circ - \phi_2'$$

$$B = 360^\circ - \alpha_{21}, \quad b = 90^\circ - \phi_1'$$

so that we have:

$$\begin{aligned} A - B &= \alpha_{12} + \alpha_{21} - 360^\circ & a + b &= 180^\circ - (\phi_1' + \phi_2') \\ \alpha_{21} &= \alpha_{12} + \Delta\alpha + 180^\circ & a - b &= \phi_1' - \phi_2' \\ A - B &= 2\alpha_{12} + \Delta\alpha - 180^\circ & & \end{aligned} \quad (6.60)$$

Substituting these values into equation (6.59) we have, after several simplifications:

$$\sin \frac{s}{2N_m} \sin \left(\alpha_{12} + \frac{\Delta\alpha}{2} \right) = \cos \phi_m \sin \frac{\Delta\lambda}{2} \quad (6.61)$$

$$\sin \frac{s}{2N_m} \cos \left(\alpha_{12} + \frac{\Delta\alpha}{2} \right) = \sin \frac{\Delta\phi'}{2} \cos \frac{\Delta\lambda}{2} \quad (6.62)$$

From equation (6.58) we solve for $\Delta\phi'$ in terms of $\Delta\phi$ and substitute into (6.62) to find:

$$\sin \frac{s}{2N_m} \cos \left(\alpha_{12} + \frac{\Delta\alpha}{2} \right) = \sin \left[\frac{M_m}{2N_m} \Delta\phi \right] \cos \frac{\Delta\lambda}{2} \quad (6.63)$$

Equation (6.61) and (6.63) are the main equations leading to the Gauss mid-latitude formulas. To derive the inverse solution we divide (6.61) by (6.63) to obtain:

$$\tan \left(\alpha_{12} + \frac{\Delta\alpha}{2} \right) = \frac{\cos \phi_m \sin \frac{\Delta\lambda}{2}}{\sin \left[\frac{M_m}{2N_m} \Delta\phi \right] \cos \frac{\Delta\lambda}{2}} \quad (6.64)$$

Note that in the inverse problem the right side will be a known quantity so that equation (6.64) may be used to find $\alpha_{12} + \Delta\alpha/2$. Knowing this quantity we can solve either equation (6.61) or (6.63) for s . For example from (6.61):

$$\sin \frac{s}{2N_m} = \frac{\cos \phi_m \sin \frac{\Delta\lambda}{2}}{\sin \left(\alpha_{12} + \frac{\Delta\alpha}{2} \right)} \quad (6.65)$$

In order to find the azimuth, the value of $\Delta\alpha$ may be computed from equation (6.47) or (6.48) which have been previously given.

The Gauss mid-latitude formulas are usually seen in series form. These may be derived by expanding $\sin (s/2N_m)$, $\sin (\Delta\lambda/2)$, and $\sin (M_m \Delta\phi / 2N_m)$ that appear in (6.61) and (6.63). For example, retaining first terms in (6.61) we have:

$$s \sin \left(\alpha_{12} + \frac{\Delta\alpha}{2} \right) = N_m \cos \phi_m \Delta\lambda \quad (6.66)$$

and from equation (6.63):

$$s \cos \left(\alpha_{12} + \frac{\Delta\alpha}{2} \right) = M_m \Delta\phi \cos \frac{\Delta\lambda}{2} \quad (6.67)$$

These equations may be used to solve the direct problem in an iterative fashion by writing equations (6.66) and (6.67) in the form:

$$\Delta\lambda = \frac{s \sin \left(\alpha_{12} + \frac{\Delta\alpha}{2} \right)}{N_m \cos \phi_m} \quad (6.68)$$

$$\Delta\phi = \frac{s \cos \left(\alpha_{12} + \frac{\Delta\alpha}{2} \right)}{M_m \cos \left(\frac{\Delta\lambda}{2} \right)} \quad (6.69)$$

where $\Delta\alpha$ could be computed directly from (6.47) or (6.48). It is clear that the precise solution of the direct problem in this manner is an iterative procedure.

A more complete series form for the inverse problem has been given by Lambert and Swick (1935), Bomford (1971, p. 137), and Lauf (1983, p. 71). Given the information for the inverse problem we compute N_m and M_m . Then compute F :

$$F = \frac{1}{12} \sin \phi_m \cos^2 \phi_m \quad (6.70)$$

We then essentially evaluate (6.48) in the form:

$$\Delta\alpha = \Delta\lambda \sin \phi_m \sec \frac{\Delta\phi}{2} + F \Delta\lambda^3 \quad (6.71)$$

Then compute:

$$\Delta\phi' = \Delta\phi \left(\frac{\sin (\Delta\phi/2)}{(\Delta\phi/2)} \right)$$

$$\Delta\lambda' = \Delta\lambda \left(\frac{\sin (\Delta\lambda/2)}{(\Delta\lambda/2)} \right)$$

$$X_1 = s_1 \sin \left(\alpha_{12} + \frac{\Delta\alpha}{2} \right) = N_m \Delta\lambda' \cos \phi_m \quad (6.72)$$

$$X_2 = s_1 \cos \left(\alpha_{12} + \frac{\Delta\alpha}{2} \right) = M_m \Delta\phi' \cos \left(\frac{\Delta\lambda}{2} \right)$$

Knowing X_1 and X_2 compute s_1 :

$$s_1 = \left(X_1^2 + X_2^2 \right)^{\frac{1}{2}} \quad (6.73)$$

Then find:

$$s = s_1 (s_1/2N_m) / \sin (s_1/2N_m)$$

$$\alpha_{12} = \tan^{-1}(X_1/X_2) - \Delta\alpha/2 \quad (6.74)$$

$$\alpha_{21} = \alpha_{12} + \Delta\alpha \pm 180^\circ$$

The importance of the Gauss mid-latitude formulas is in the solution of the inverse problem through equations (6.64) and (6.65) where no iterative procedures are required. The accuracy of the Gauss mid-latitude formulas is about 1 part per million for lines of 100 km.

6.5 The Bowring Formulas

Bowring (1981) has derived equations for the direct and inverse problems for the geodesic for lines up to 150 km in length. The derivation is given in detail by Bowring and will not be repeated here. The method uses a conformal projection of the ellipsoid on a sphere called the Gaussian projection of the second kind. In this application the scale factor is taken to be one at the starting point of the line. In addition the first and second derivatives of scale factor with respect to latitude are set to zero. The geodesic from the ellipsoid is then projected to the corresponding line on the sphere where spherical trigonometry can be applied.

The procedure for the direct and inverse solution is non-iterative using the following equations:

Common Equations

$$A = (1 + e'^2 \cos^4 \phi_1)^{1/2}$$

$$B = (1 + e'^2 \cos^2 \phi_1)^{1/2}$$

$$C = (1 + e'^2)^{1/2}$$

(6.75)

$$w = A(\lambda_2 - \lambda_1)/2$$

$$\Delta\phi = \phi_2 - \phi_1$$

$$\Delta\lambda = \lambda_2 - \lambda_1$$

Direct Problem Equations

$$\sigma = sB^2/(aC)$$

$$\lambda_2 = \lambda_1 + \frac{1}{A} \tan^{-1} \left(\frac{A \tan \sigma \sin \alpha_{12}}{B \cos \phi_1 - \tan \sigma \sin \phi_1 \cos \alpha_1} \right)$$

$$D = \frac{1}{2} \sin^{-1} \left[\sin \sigma (\cos \alpha_{12} - \frac{1}{A} \sin \phi_1 \sin \alpha_{12} \tan w) \right]$$

(6.76)

$$\phi_2 = \phi_1 + 2D \left[B - \frac{3}{2} e'^2 D \sin (2\phi_1 + \frac{4}{3} BD) \right]$$

$$\alpha_2 = \tan^{-1} \left[\frac{-B \sin \alpha_{12}}{\cos \sigma (\tan \sigma \tan \phi_1 - B \cos \alpha_1)} \right]$$

Inverse Problem Equations

$$D = \frac{\Delta \phi}{2B} \left[1 + \frac{3e'^2}{4B^2} \Delta \phi \sin (2\phi_1 + \frac{2}{3} \Delta \phi) \right]$$

$$E = \sin D \cos w$$

$$F = \frac{1}{A} \sin w (B \cos \phi_1 \cos D - \sin \phi_1 \sin D)$$

$$\tan G = \frac{F}{E}; \quad \sin \frac{\sigma}{2} = (E^2 + F^2)^{\frac{1}{2}} \quad (6.77)$$

$$\tan H = \left[\frac{1}{A} (\sin \phi_1 + B \cos \phi_1 \tan D) \tan w \right]$$

$$\alpha_1 = G - h; \quad \alpha_2 = G + H \pm 180^\circ; \quad s = aC/B^2$$

Meade (1981) discusses the accuracy of this solution indicating accuracies of 1 or 2 mm for the direct or inverse solution for lines on the order of 120 km in length. For 150 km lines the error in an inversed distance increased to 3 or 4 mm. For lines up to 100 km the azimuth error will be on the order of 0.001 second.

6.6 The Chord Method

Another procedure to solve the inverse and direct problem is to work with the chord between the two points of interest. In section 4.19 and 4.23 we discussed methods for working with a chord between two points. In 4.19 we considered the chord and its normal section azimuth between two points on or above the ellipsoid. In section 4.23 we discussed the conversion of a geodesic or normal section length between two points on the ellipsoid to a chord and vice versa. We now apply these equations to the solution of the direct and inverse problem.

6.61 The Inverse Problem

Given $\phi_1, \lambda_1, \phi_2, \lambda_2$ we calculate the X, Y, Z coordinates from equation (3.152) assuming the height is zero. The chord distance is then:

$$c = ((X_2 - X_1)^2 + (Y_2 - Y_1)^2 + (Z_2 - Z_1)^2)^{1/2} \quad (6.78)$$

This chord distance can be converted to a geodesic length using (4.106) or a normal section length using equation (4.107). The normal section azimuth can be computed in closed form from (4.71) where A is the first point. If the geodesic azimuth is needed, equations such as (4.111) can be used. The back azimuth, if needed, can also be found from (4.71) making point A the second of the two points.

6.62 The Direct Problem

Recall for the direct problem we are given $\phi_1, \lambda_1, \alpha_{12}$, and s. For convenience we can set $\lambda_1 = 0$ and solve for a longitude difference with respect to the first point. In this case the rectangular coordinates of the first point are (from 3.152):

$$\begin{aligned} X_1 &= N_1 \cos \phi_1 \\ Y_1 &= 0 \\ Z_1 &= N_1(1-e^2) \sin \phi_1 \end{aligned} \quad (6.79)$$

The coordinate differences would be:

$$\begin{aligned} \Delta X &= X_2 - X_1 \\ \Delta Y &= Y_2 \\ \Delta Z &= Z_2 - Z_1 \end{aligned} \quad (6.80)$$

We now invert (4.67) and at the same time set $\lambda = 0$. We find:

$$\begin{pmatrix} \Delta X \\ \Delta Y \\ \Delta Z \end{pmatrix} = \begin{pmatrix} -\sin \phi_1 & 0 & \cos \phi_1 \\ 0 & 1 & 0 \\ \cos \phi_1 & 0 & \sin \phi_1 \end{pmatrix} \begin{pmatrix} u \\ v \\ w \end{pmatrix} \quad (6.81)$$

where the local coordinates are (see 4.60):

$$\begin{aligned} u &= c \cos V \cos \alpha_{12} \\ v &= c \cos V \sin \alpha_{12} \\ w &= c \sin V \end{aligned} \quad (6.82)$$

Substituting (6.82) into (6.81) we have:

$$\begin{aligned} \Delta X &= -c(\sin \phi_1 \cos V \cos \alpha_{12} - \sin V \cos \phi_1) \\ \Delta Y &= c \cos V \sin \alpha_{12} \\ \Delta Z &= c(\cos \phi_1 \cos V \cos \alpha_{12} + \sin \phi_1 \sin V) \end{aligned} \quad (6.83)$$

We know c and α_{12} on the right hand side of (6.83). Assuming we know V , we can use (6.83) to find ΔX , ΔY , and ΔZ . We then compute the rectangular coordinates of the second point.

$$\begin{aligned} X_2 &= X_1 + \Delta X \\ Y_2 &= \Delta Y \\ Z_2 &= Z_1 + \Delta Z \end{aligned} \quad (6.84)$$

Given these coordinates we can then compute the latitude and longitude from (as will be discussed in section 6.8):

$$\tan \phi_2 = \frac{Z_2}{(1-e^2)(X_2^2 + Y_2^2)^{\frac{1}{2}}} \quad (6.85)$$

$$\tan \Delta \lambda = \frac{Y_2}{X_2} \quad (6.86)$$

These equations would complete the solution of the direct problem.

In solving (6.83) we assumed that we had V . This angle V is the negative of the dip angle discussed in section 4.17. For example, from (4.52) we can write:

$$-V = \frac{s}{2N_1} (1 + n_1^2 \cos^2 \alpha_{12}) - \frac{s^2}{2N_1^2} n_1^2 t_1 \cos \alpha_{12} \quad (6.87)$$

A simplified value for V can be derived from Figure 6.5 which assumes the two points are on a sphere whose radius is the radius (R_α) of curvature in the direction of the line.

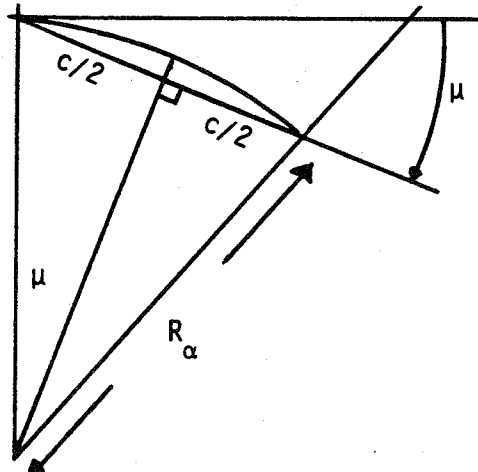

Figure 6.5
Approximate Determination of the "Dip Angle"

We have:

$$\sin \mu = \sin(-V) = \frac{c}{2R_\alpha} \quad (6.88)$$

The use of (6.88) or even (6.87) could create a small error in the computed coordinates. If the rectangular coordinates are correct the equation of the ellipse must be satisfied. Specifically, from (3.153), we should have:

$$\left[X_2^2 + Y_2^2 + \frac{Z_2^2}{(1-e^2)} \right]^{1/2} - a = 0 \quad (6.89)$$

If V is incorrect the right hand side will equal (say) h . Knowing h , a correction to V can be computed (Vincenty, 1977) as follows:

$$-dV = \frac{h}{c \cos V} \quad (6.90)$$

The corrected vertical angle would be:

$$V_{i+1} = V_i + dV \quad (6.91)$$

Which can be used in (6.83) to obtain improved values of ΔX , ΔY , and ΔZ . After the iteration cycle has converged (e.g. $h \leq 1$ mm) the final set of X_2 , Y_2 , Z_2 values can be used in (6.85) and (6.86) to obtain the latitude and longitude of the second point.

6.7 Accuracy of the Direct and Inverse Methods for Medium Length Lines

In the previous sections we have discussed a number of different methods for solving the inverse and direct problem. Each method had approximations associated with it in terms of series truncation or geometric approximations. In some cases we have quoted guidelines on the accuracy of the equations. But more specific accuracy estimates can be obtained if a series of test lines are computed with the most accurate set of formulas with comparisons made with the results for the approximate methods. Such computations have been carried out by Gupta (1972) for a number of methods and by Badi (1983) for the Bowring method.

Before discussing the accuracies of each method we should put in context the accuracy we might want in position computations. For example, we first recall that 1" of arc corresponds to ~ 30 m on the surface of the ellipsoid. We have then:

Arc Measure	Linear Measure
1"	30 m
0":1	3 m
0":01	.3 m = 30 cm
0":001	.03 m = 3 cm
0":0001	.003 m = 0.3 cm = 3 mm
0":00001	.0003 m = 0.03 cm = .3 mm

If we are given a set of latitudes and longitudes we would like to have them given such that any distance computed from them should be correct (for consistency purposes) to 1 mm. This would imply that ϕ 's and λ 's should be given to an accuracy on the order of 0":00001. There may be cases where such a stringent criteria can be relaxed depending on the application of the results.

The point of the above discussion is to note that when we discuss the accuracy of the direct solution we must clearly specify what is our accuracy criteria. We should not imply that a given formula is accurate for lines of XXX km.

The tests made by Gupta consisted of lines of varying length and azimuths and latitude of the first point. In most cases there is a sensitivity to the results depending on these three quantities. A complete listing of all results is not appropriate here. It is sufficient to tabulate the maximum distance at the poorest azimuths and latitudes, for which the specific equations yield the given accuracy. Such results are given in the following table:

**Maximum Length of Line for Which a Given Direct Solution
Achieves the Given Accuracy**
(Distances are in km)

	0"00001	0"0001	0"001	0"01
Legendre Series (4 terms)	30	40	80	100
Legendre Series (5 terms)	60	90	100	200
Puissant (short, 6.51)	10	10	10	10
Puissant (long, 6.40)	10	20	40	80
Bowring Chord	70	100	300	700

The poorest accuracy in these results usually occurs at the high latitudes. (The highest latitude used in these tests was 70°). For example at a latitude of 10° the maximum distance for the Legendre series with 5th order derivatives is 100 km for an accuracy of 0"00001 instead of 60 km given in the table.

From these results we conclude that the Bowring formulas for the direct problem will yield the best accuracy of the equations described in this discussion.

The accuracy of the inverse problem can be described in a similar way. In the following table we compare the distance and azimuth errors for the Gauss Mid-Latitude Formulas and the Bowring Formulas. Again we have chosen maximum errors that do depend on azimuth and latitude.

**Maximum Error in the Solution of the Inverse
Problem for Various Length Lines**

Line Length km	Gauss Mid Latitude		Bowring	
	Azimuth(")	Distance(mm)	Azimuth(")	Distance(mm)
50	0"0048	4	0"0003	0.1
100	0"020	33	0"0024	1.1
200	0"083	136	0"0049	9.7

The Bowring results are clearly the better. The errors are still quite sensitive to latitude and azimuth. For a 100 km 0° azimuth the error in the Bowring formulas at latitude 10° is 0.08 mm increasing to 1.1 mm at 40° .

6.8 The Inverse Problem for Space Rectangular Coordinates

Given ϕ , λ , and h of a point we compute the space rectangular coordinates as follows (see 3.152):

$$\begin{aligned} X &= (N + h) \cos\phi \cos\lambda \\ Y &= (N + h) \cos\phi \sin\lambda \\ Z &= (N(1-e^2) + h) \sin\phi \end{aligned} \tag{6.92}$$

We now examine the question of computing ϕ , λ , h given X , Y , Z and the ellipsoid parameters. The solution is not straight forward as N is a function of latitude. A number of iterative and closed form solutions of this problem have been presented. We first consider an iterative solution suggested by Hirvonen and Moritz (1963).

We first find the longitude by dividing the Y by the X equation of (6.92):

$$\tan\lambda = \frac{Y}{X} \tag{6.93}$$

We then consider the meridian section shown in Figure 6.6:

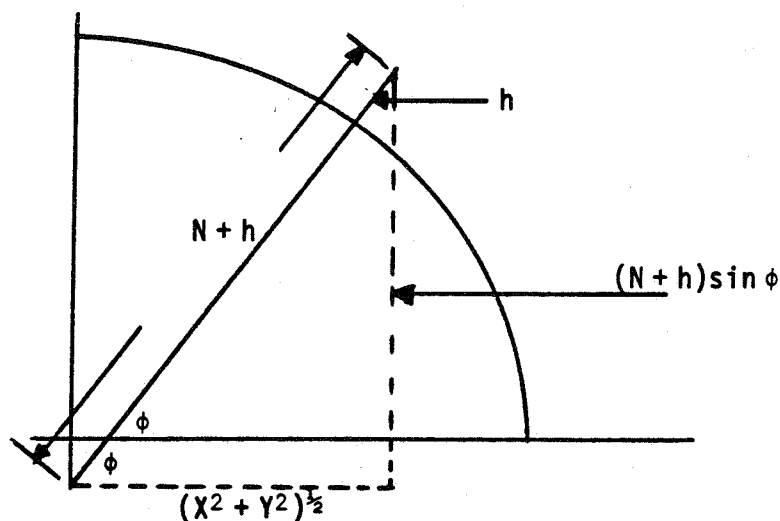

Figure 6.6
A Meridian Section Showing a Point Above the Ellipsoid

We have:

$$\tan\phi = \frac{(N + h) \sin\phi}{\sqrt{X^2 + Y^2}} \quad (6.94)$$

Now $Z = N\sin\phi - e^2N\sin\phi + h\sin\phi$ or $(N + h)\sin\phi = Z + e^2N\sin\phi$

so

$$\tan\phi = \frac{Z + e^2N\sin\phi}{\sqrt{X^2 + Y^2}} \quad (6.95)$$

We need to solve this equation by iteration so we first write:

$$\tan\phi = \frac{Z}{\sqrt{X^2 + Y^2}} \left[1 + \frac{e^2N\sin\phi}{Z} \right] \quad (6.96)$$

If, as a first approximation, we take $h = 0$, $Z = N(1 - e^2)\sin\phi$, equation (6.96) can be written as:

$$\tan\phi_1 = \frac{Z}{\sqrt{X^2 + Y^2}} \left[1 + \frac{e^2}{1 - e^2} \right] \quad (6.97)$$

or

$$\tan\phi_1 = \frac{1}{1 - e^2} \cdot \frac{Z}{\sqrt{X^2 + Y^2}}$$

This equation is exact when $h = 0$, and may be used to find a first approximation for the desired latitude. With this approximation equation (6.95) can be iterated to convergence.

From the first two equations of (6.92) we can find h :

$$h = \frac{\sqrt{X^2 + Y^2}}{\cos\phi} - N \quad (6.98)$$

From the third equation of (6.29) we have:

$$h = \frac{Z}{\sin\phi} - N + e^2N \quad (6.99)$$

The choice between the use of (6.98) or (6.99) depends on the approximate latitude. In the polar regions (6.99) should be more stable than (6.98) while the converse will be true in equatorial regions.

In 1976 Bowring described an iterative procedure that converges faster than the one just discussed. We consider (see Figure 6.7) a meridian ellipse with point Q located at some elevation above the ellipsoid with P being the corresponding point on the ellipsoid. Let C be the center of curvature of the meridian ellipse at point P. The distance CP is the meridian radius of curvature, M.

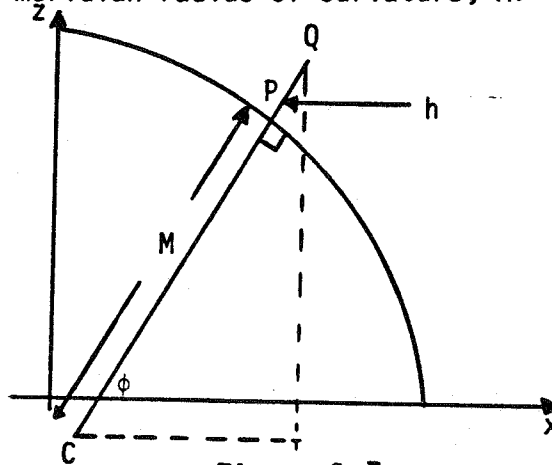

Figure 6.7
Meridian Ellipse for the Bowring Derivation

The x coordinate of C is:

$$x_c = x_p - M \cos\phi \quad (6.100)$$

Using (3.42) for x_p and (3.88) for M, (6.100) reduces to

$$x_c = a e^2 \cos^3\phi / W^3 \quad (6.101)$$

Using (3.66) this becomes:

$$x_c = a e^2 \cos^3\beta \quad (6.102)$$

In a similar fashion we compute the z coordinate of C. We find:

$$z_c = -e'^2 b \sin^3\beta \quad (6.103)$$

From Figure 6.7 we see:

$$\tan\phi = \frac{z_Q - z_C}{x_Q - x_C}$$

or substituting for x_c and z_c we have

$$\tan \phi = \frac{z_0 + e'^2 b \sin^3 \beta}{x_0 - a e'^2 \cos^3 \beta} \quad (6.104)$$

In terms of X , Y , and Z we can write (6.104) as:

$$\tan \phi = \frac{Z + e'^2 b \sin^3 \beta}{\sqrt{X^2 + Y^2} - a e'^2 \cos^3 \beta} \quad (6.105)$$

Equation (6.105) is the basic equation to be iterated for the Bowring solution. The initial approximate value of β can be found from (3.28) and (3.29):

$$\tan \beta_0 = \frac{a}{b} \frac{Z}{(X^2 + Y^2)^{1/2}} \quad (6.106)$$

Any updated values of β that are needed can be computed from (3.63):

$$\tan \beta = (1 - f) \tan \phi \quad (6.107)$$

where ϕ will be computed from (6.105).

For terrestrial applications a single iterative cycle of (6.105) starting with (6.106) is all that is needed to obtain results accurate to better than 0.1 mm. At heights of 5000 km the error of such computation could reach 39 mm which could be eliminated by another iteration.

The height could be determined from (6.98) or (6.99). However, a more convenient way for any technique was suggested by Bartelme and Meissl (1975) as part of their derivation of another procedure for the determination of ϕ , λ , and h . We start with the meridian ellipse and a circle passing through the point of interest as shown in Figure 6.8.

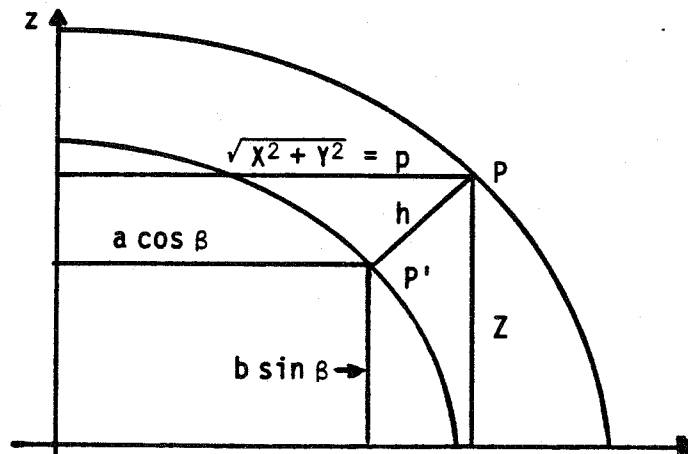

Figure 6.8
Geometry for the Determination of h

We note that the x and z coordinates of P' on the ellipsoid are $a \cos \beta$ and $b \sin \beta$ from (3.28) and (3.29). We then have:

$$h^2 = (p - a \cos \beta)^2 + (z - b \sin \beta)^2 \quad (6.108)$$

The sign of h is assigned to be the same as the sign of the first term in parenthesis. The use of equation (6.108) is recommended for height computations because of its simplicity and stability although it fails if the point is at the poles.

Vincenty (1980a) suggested an improvement in the Bowring procedure by introducing an auxiliary ellipsoid that passes through the point being transformed. This method is especially helpful when an elevation is approximately known or is computed in an approximate way.

Closed formulas for the evaluation of ϕ , λ , and h from X, Y, Z have been proposed by a number of authors (e.g. Paul (1973) and Heikkinen (1982)). The computational steps for the Heikkinen procedure are as follows:

- 1) $r = (X^2 + Y^2)^{\frac{1}{2}}$
- 2) $F = 54b^2Z^2$
- 3) $G = r^2 + (1-e^2)Z^2 - e^2E^2; (E^2 = a^2 - b^2)$
- 4) $c = e^4Fr^2/G^3$
- 5) $s = \sqrt[3]{1+c + \sqrt{c^2 + 2c}}$
- 6) $P = \frac{F}{3(s + \frac{1}{s} + 1)^2G^2}$
- 7) $Q = \sqrt{1 + 2e^4P} \quad (6.109)$
- 8) $r_0 = \frac{-Pe^2r}{1+Q} + \left[\frac{a^2}{2} \left(1 + \frac{1}{Q} \right) - \frac{P(1-e^2)Z^2}{Q(1+Q)} - \frac{Pr^2}{2} \right]^{\frac{1}{2}}$
- 9) $U = \sqrt{(r - e^2r_0)^2 + Z^2}$
- 10) $V = \sqrt{(r - e^2r_0)^2 + (1-e^2)Z^2}$
- 11) $z_0 = \frac{b^2Z}{aV}$
- 12) $h = U \left(1 - \frac{b^2}{aV} \right)$
- 13) $\tan \phi = \frac{Z + e'^2z_0}{r}$
- 14) $\tan \lambda = Y/X$

Any errors in the application of these equations would stem from instability situations. The formulas of Heikkinen are apparently stable (Vincenty, 1982, private communication).

In terms of computer evaluation time the technique of Heikkinen is the slowest. If we let the time for this approach to be 1, the time for the Bowring approach would be 0.73, for the Vincenty (1980) approach, 0.66; and for the Hirvonen-Moritz approach, 1.05.

7. ASTRO-GEODETTIC INFORMATION

7.1 Astronomic Coordinates

To this point in our discussion we have considered geodetic coordinates that are defined with respect to some specific system of axes and planes implied by these axes. We have latitude measured from the equatorial plane that is perpendicular to the Z axis or rotation axis of the ellipsoid. The geodetic longitude is the angle between an initial meridian (containing the X and Z axes) and the meridian passing through the point of interest.

In the real world where measurements are made with respect to the direction of the gravity vector, at a point on the surface of the earth, we cannot directly determine geodetic latitude, longitude, normal section azimuth, vertical angle etc., since the horizontal plate of the instruments used for these measurements are oriented by making the horizontal plate of the instrument perpendicular to the direction of the gravity. The quantities measured with respect to a gravity vector orientation are generally called astronomic quantities. We have astronomic latitude ϕ ; astronomic longitude Λ ; astronomic azimuth A ; astronomic vertical angle V ; or astronomic zenith distance z' . In order to define such quantities it is necessary to define a coordinate system and initial planes for referencing (for example) astronomic latitude and astronomic longitude. The definitions of these systems is widely tied to observables related to the physical earth.

It is not the intention of our discussion to go into detail in the definitions of astronomic coordinate systems. Such discussions may be found in Mueller (1969, p. 19), Bomford (1980, p. 97), Vaniček and Krakiwsky (1982, p. 296), Mueller (1981, p. 9) etc. It is important for us, however, to briefly review some appropriate definitions and applications.

The Z axis used for astronomic referencing purposes is related to the rotation axis of the earth. Such an axis requires a precise definition since the instantaneous rotation axis does not remain fixed in position with respect to the crust of the earth. The first monitoring of the motion of the pole was started in 1899 through the defined latitudes of five stations of the International Latitude Service. The data from these stations have been used to define the Conventional International Origin (CIO) which is the average terrestrial pole of 1900-05. Polar motion values have also been determined by the International Polar Motion Service (IPMS) which uses data from a large number of observatories, and by the Bureau International de l'Heure (BIH). Changes in polar motion are now also routinely obtained from the analysis of the motion of satellites. Each determination of polar motion may be slightly different depending on star catalogues used, adopted station coordinates, observational procedures, constants adopted etc. In the near future improved determinations of polar motion and the Z axis will be possible using new and improved observational procedures and processing techniques. It should be clear that polar motion determinations since 1899 will not have a uniform accuracy and a uniform reference Z axis.

For further discussion we assume that we have a Z axis of what is called the Conventional Terrestrial System (CTS) (Mueller, 1981). The instantaneous rotation axis is located with respect to this Z axis by the elements of polar motion x_p , y_p . The astronomic latitude of a point, on the surface of the earth, would be the angle measured between the equator (perpendicular to the mean rotation axis) and the direction of the gravity vector at the point of interest. The mean astronomic latitude (ϕ_M) can be obtained from the instantaneous astronomic latitude (ϕ_I) (i.e. with respect to the instantaneous equator) using the coordinates (x_p , y_p) of the instantaneous pole with respect to the reference pole using (Mueller, 1969, p. 87):

$$\phi_M = \phi_I + y_p \sin \Lambda - x_p \cos \Lambda \quad (7.1)$$

To define the instantaneous astronomic longitude we first define the instantaneous astronomic meridian plane as that "plane containing the astronomic normal at P and parallel to the instantaneous rotation axis of the earth" (Mueller, 1969, p. 19). The mean astronomic meridian will be that plane containing the astronomic normal at P, and that is parallel to the Z axis of the Conventional Terrestrial System. The astronomic longitude is the angle between an initial meridian (today defined by the BIH) and the astronomic meridian passing through the point of interest. Values of the mean astronomic longitude (Λ_M) can be obtained from the instantaneous astronomic longitude (Λ_I) through the application of the polar motion correction (Mueller, 1969, p. 87):

$$\Lambda_M = \Lambda_I - (x_p \sin \Lambda + y_p \cos \Lambda) \tan \phi \quad (7.2)$$

The first substantial agreement on the definition of the initial meridian was reached at the International Meridian Conference that was held in Washington in October 1884 (Howse, 1980). There the initial meridian was defined to be "passing through the centre of the transit instrument at the Observatory of Greenwich". Since that time improved definitions have been adopted. With various definitions in existence at various times it is clear that astronomic longitudes considered over an extended period of time may not form a homogeneous data set. In the United States, astronomic longitudes were originally linked to a defined longitude for a U.S. Naval Observatory site. However, this longitude and the star catalogs used from 1922 were inconsistent with that used by the Bureau International de l'Heure (BIH). Petty and Carter (1978) estimate an average longitude correction of $-0^{\circ}50$ (positive west longitude) for astronomic longitudes determined in the U.S. prior to 1962. This time dependent correction is called the observatory correction and should be applied to astronomic longitudes released by the National Geodetic Survey prior to 1978 (Petty, private communication, 1981).

Today the initial axes (X, Z) are defined by an assigned set of astronomic longitudes at approximately 50 time observatories through out the world that submit data to the BIH in Paris. Such measurements enable the precise definition of an initial meridian which is now not physically observable at Greenwich. In practice, polar motion corrections are applied to obtain a "mean" initial meridian.

An astronomic azimuth is the angle between astronomic north (or the astronomic meridian plane) and the plane containing the gravity vector at the observation point and that passes through the point being observed. Since the astronomic plane can vary due to variations in the rotation axis described by polar motion, we should speak of an instantaneous astronomic azimuth (A_I) and a mean astronomic azimuth (A_M). The two azimuths are related as follows (Mueller, 1969, p. 88):

$$A_M = A_I - (x_p \sin \Lambda + y_p \cos \Lambda) \sec \phi \quad (7.3)$$

In subsequent discussions we will refer only to the mean astronomic azimuth. It will be measured from the north in a clockwise direction.

The astronomic zenith distance (Z') is the angle from the zenith defined by the direction of the gravity vector to the point being observed.

In the above discussion we have considered astronomic measurements referred to the direction of the gravity vector at a point on the earth's surface. For applications that compare the astronomic and geodetic coordinates (see the following sections) it is important that the astronomic coordinates be reduced to the ellipsoid or in practice to the geoid. To do this plumb line curvature corrections must be made as described in Heiskanen and Moritz (1967, p. 193).

Figure 7.1 identifies various quantities with respect to the axes of the Conventional Terrestrial System.

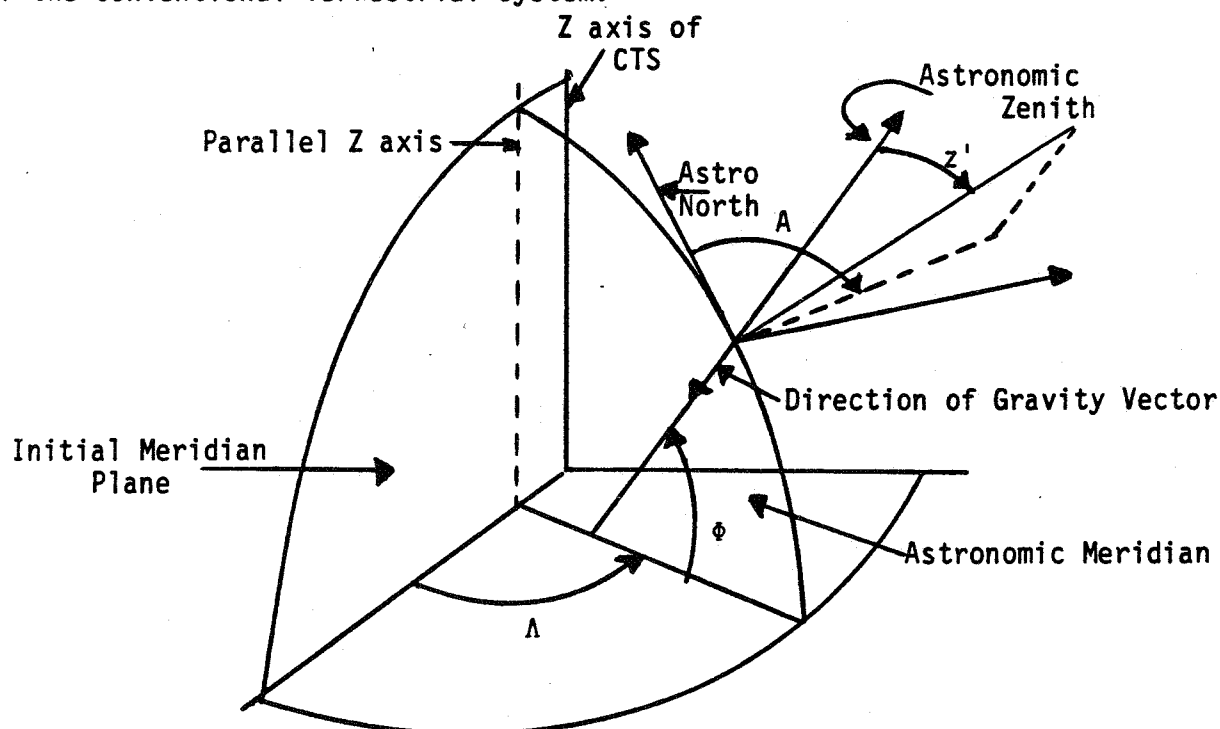

Figure 7.1
Measured Astronomic Quantities.

7.2 A Comparison of Astronomic and Geodetic Angular Quantities

Astronomic and geodetic quantities such as latitude, longitude, azimuth and zenith distance will primarily be different because such quantities are measured with respect to different zenith directions. The astronomic quantities are measured with respect to a zenith defined by the direction of the gravity vector while the geodetic quantities are defined with respect to a zenith defined by a normal to the ellipsoid.

It is also possible that the coordinates differ because of the use of different reference poles and different initial meridians for the astronomic and geodetic systems. Ideally we would like such systems to be the same but in reality they may not be.

For our first analytic examination of the differences between the coordinates, we will assume, however, that the astronomic reference axis is parallel to the rotation axis of our reference ellipsoid. We will also assume that the longitudes are measured from initial meridians that are parallel. This derivation follows that found in Heiskanen and Moritz (1967, p. 184).

We now consider a unit sphere about point A on the surface of the earth as shown in Figure 7.2. The intersection of the rotation axis of the ellipsoid with the sphere is designated P. (Note that there is only one pole as we have assumed that the geodetic and astronomic rotation axes are parallel). The normal to the ellipsoid passing through A will intersect the sphere at Z_G , the geodetic zenith at A. We now extend the direction of the gravity vector at A so that it intersects the auxiliary sphere at Z_A which is called the astronomical zenith at A. We let m be the point of intersection of the line of vision and the unit sphere when the theodolite (leveled with respect to the gravity vector) is pointed at the target M. Points Z_G and Z_A are connected to the points P and m by great circles. The arc mZ_A is the measured zenith distance to the point M and is called z' . The plane $AZ_A m$ is the vertical plane at point A passing through M. The arc mZ_G is the geodetic zenith distance and is designated as z . The plane $AZ_G m$ is the plane of the direct normal section from A to M measured with respect to the ellipsoid normal passing through A. We note that the arc $Z_A P$ is $90^\circ - \phi$. The plane $AZ_G P$ is the plane of the geodetic meridian at A. The plane $AZ_A P$ is the plane of the astronomical meridian at A. The angle $Z_G P Z_A = (\Delta\lambda)$ is the angle between the astronomic and geodetic meridians at A. Assuming the astronomic and geodetic longitudes are computed from the same initial meridian we have

$$\Delta\lambda = \Lambda - \lambda \quad (7.4)$$

We also let the arc $Z_G Z_A$ be θ which is the total deflection of the vertical at point A. The angle $PZ_G Z_A$ is the geodetic azimuth of the (γ) plane $AZ_G Z_A$ which contains the total deflection of the vertical at A. The corresponding astronomic azimuth of the plane $AZ_G Z_A$ is γ' .

We draw the arc $Z_A Z_2$ from Z_A perpendicular to the geodetic meridian PZ_G . Then the arc $Z_G Z_2$ is ξ which is the component of the total deflection along the meridian. The arc $Z_A Z_2$ is η which is the component of the total deflection of the vertical in the prime vertical direction.

The geodetic (normal section) azimuth of the plane AZ_G is the angle PZ_G which is designated α . The angle PZ_A designated A is the astronomic azimuth of the plane AZ_A .

From the right spherical triangle $Z_A Z_2 P$ we have:

$$\cos (\Lambda - \lambda) = \tan \phi \cot (\phi + \xi) \quad (7.5)$$

$$\sin \eta = \sin (\Lambda - \lambda) \cos \phi \quad (7.6)$$

Since η and $(\Lambda - \lambda)$ are small angles and $\phi \approx \phi$, we can write equation (7.6) as:

$$\eta = (\Lambda - \lambda) \cos \phi \quad (7.7)$$

or

$$(\Lambda - \lambda) = \eta \sec \phi \quad (7.8)$$

Assuming that $\cos (\Lambda - \lambda) = 1$ in equation (7.5) we can show that:

$$\phi - \phi = \xi \quad (7.9)$$

Equations (7.7) (7.8) and (7.9) are the basic equations expressing the components ξ and η of the deflection of the vertical in terms of astronomic and geodetic coordinates.

They are only valid when the assumptions made about the geodetic and astronomic pole, and the initial meridians are valid. Values of ξ and η as defined by these equations are called astrogeodetic deflections of the vertical. Since the geodetic coordinates will depend on the dimensions of the reference ellipsoid and, more generally, on the geodetic datum used for referencing the geodetic coordinates, astro-geodetic deflections are (geodetic) datum dependent quantities.

Other interesting relationships may be derived from triangle $Z_G Z_A Z_2$. Considering the triangle to be a plane triangle we can write:

$$\begin{aligned}\xi &= \theta \cos \gamma \\ \eta &= \theta \sin \gamma \\ \tan \gamma &= \frac{\eta}{\xi}\end{aligned}\tag{7.10}$$

$$\theta = \frac{\xi}{\cos \gamma} = \frac{\eta}{\sin \gamma} = \sqrt{\xi^2 + \eta^2}$$

If needed we could substitute expressions for ξ and η into equation (7.10).

We next consider the relationship between the astronomic azimuth A and the geodetic azimuth α . To do this we first designate angle $mZ_G Z_A$ as R and angle $mZ_A T$ as R_1 . Then:

$$\begin{aligned}\alpha &= R + \gamma \\ A &= R_1 + \gamma'\end{aligned}\tag{7.11}$$

From the triangle $Z_G Z_A P$ in which the angle at Z_A is $180^\circ - \gamma'$ we have:

$$-\cos \gamma' = -\cos \gamma \cos(\Lambda - \lambda) + \sin \gamma \sin(\Lambda - \lambda) \sin \phi\tag{7.12}$$

Assuming $\cos(\Lambda - \lambda) = 1$, $\sin(\Lambda - \lambda) = (\Lambda - \lambda)$, equation (7.12) may be written as:

$$\cos \gamma - \cos \gamma' = (\Lambda - \lambda) \sin \gamma \sin \phi\tag{7.13}$$

If we substitute equation (7.8) into (7.13) we obtain:

$$\cos \gamma - \cos \gamma' = \eta \tan \phi \sin \gamma\tag{7.14}$$

We can now use the trigonometric identity given in equation (5.12) so we have:

$$\cos \gamma - \cos \gamma' = -2 \sin \frac{1}{2}(\gamma + \gamma') \sin \frac{1}{2}(\gamma - \gamma') = \eta \tan \phi \sin \gamma\tag{7.15}$$

Letting $\frac{1}{2}(\gamma + \gamma') = \gamma$ and $\sin \frac{1}{2}(\gamma - \gamma') = \frac{(\gamma - \gamma')}{2}$ we have:

$$\gamma' - \gamma = \eta \tan \phi$$

or (7.16)

$$\gamma' - \gamma = (\Lambda - \lambda) \sin \phi = (\Lambda - \lambda) \cos(90^\circ - \phi)$$

Now the spherical triangle $mZ_G Z_A$ is similar to the triangle $Z_G Z_A P$ in the following way: the vertex P corresponds to the vertex m , the angle q (at m) corresponds to the angle $(\Lambda - \lambda)$ and the sides z' and z correspond to the sides $90^\circ - \phi$ and $90^\circ - \phi - \gamma'$. γ' corresponds to R_1 and γ to R . With this analogy the last equation of (7.16) may be re-written:

$$R_1 - R = q \cos z' \quad (7.17)$$

From the triangle $mZ_G Z_A$ we have:

$$\sin q = \sin \theta \frac{\sin R}{\sin z'} \quad (7.18)$$

Since q and θ are small $\sin q \approx q$, and $\sin \theta \approx \theta$, equation (7.18) may be used in (7.17) to write:

$$R_1 - R = \frac{\theta \sin R}{\tan z'} \quad (7.19)$$

Adding equation (7.16) and (7.19) we have:

$$(R_1 - R) + (\gamma' - \gamma) = \frac{\theta \sin R}{\tan z'} + \eta \tan \phi \quad (7.20)$$

Differencing the two equations in (7.11) we find:

$$A - \alpha = (R_1 - R) + (\gamma' - \gamma) \quad (7.21)$$

Now let $R = \alpha - \gamma$ so that we can use equation (7.20) in equation (7.21) to write:

$$A - \alpha = \eta \tan \phi + \frac{\theta \sin(\alpha - \gamma)}{\tan z'} \quad (7.22)$$

Expanding the sine of the difference of two angles:

$$A - \alpha = \eta \tan \phi + \frac{\theta \sin \alpha \cos \gamma - \theta \cos \alpha \sin \gamma}{\tan z'} \quad (7.23)$$

From equation (7.10) we may substitute for $\theta \cos \gamma$ and $\theta \sin \gamma$, and taking $z'=z$, we can write:

$$A - \alpha = \eta \tan \phi + \frac{\xi \sin \alpha - \eta \cos \alpha}{\tan z} \quad (7.24)$$

Equation (7.24) may also be written in the following form:

$$A - \alpha = (\Lambda - \lambda) \sin \phi + (\xi \sin \alpha - \eta \cos \alpha) \cot z \quad (7.25)$$

This equation gives the relationships between the astronomic and geodetic azimuth as a function of the astro geodetic deflections of the vertical. In most triangulation networks $z=90^\circ$ so that $\cot z=0$ and the last term in equation (7.25) is negligible. In this case equation (7.25) is written in a more familiar form:

$$A - \alpha = \eta \tan \phi = (\Lambda - \lambda) \sin \phi \quad (7.26)$$

Given $\Lambda, \lambda, A, \phi$ we may use equation (7.26) to compute α , the geodetic azimuth of a line. We have from (7.26):

$$\alpha = A - (\Lambda - \lambda) \sin \phi \quad (7.27)$$

Equation (7.26) and/or (7.27) are referred to as Laplace's equations. The geodetic azimuth calculated from equation (7.27) is called the Laplace azimuth.

Writing (7.25) in the form of (7.27) we obtain the "extended" Laplace equation:

$$\alpha = A - (\Lambda - \lambda) \sin \phi - (\xi \sin \alpha - \eta \cos \alpha) \cot z \quad (7.28)$$

or substituting for ξ and η

$$\alpha = A - \sin \alpha \cot z (\phi - \phi) - (\sin \phi - \cos \phi \cos \alpha \cot z)(\Lambda - \lambda) \quad (7.29)$$

In order to compute a Laplace azimuth it is necessary to observe the astronomic azimuth and longitude at a given point and to have available the geodetic longitude. (We shall see later that an exact value of λ is not needed as the Laplace equation will be used in an adjustment of the geodetic data). Stations at which these observations are made are called Laplace stations. Such stations have been established in most existing triangulation networks. The spacing of such stations can vary from 10 km to 300 km depending on the size of the network and the accuracy intended for the results.

The primary purpose of including a Laplace azimuth in a geodetic network is to provide azimuth orientation for the network in such a way that orientation errors are spread uniformly in the network. In addition, the use of the equations such as (7.28) tends to enforce the condition of the assumptions made in deriving the Laplace equation, i.e. the parallelism of the pole axes and the parallelism of the initial meridian (Moritz, 1978, p. 68).

In geodetic networks being developed today and in the future, the need for Laplace azimuths has been significantly reduced due to the incorporation of satellite position determinations into the network adjustment. Such determinations provide both orientation and scale information that (with appropriate station spacing) strengthens the geodetic network. The incorporation of such positions into the network is discussed in Moose and Henriksen (1976), Ashkenazi (1981), Vincenty (1982) and many others.

One last effect needs to be considered and that is the discrepancy between the astronomic and geodetic zenith distances. To do this we consider the triangle mZ_GZ_A , as shown in Figure 7.3 where the arc Z_GZ' is perpendicular to mZ_A . Then the desired difference $z'-z$ will be the arc Z_AZ' .

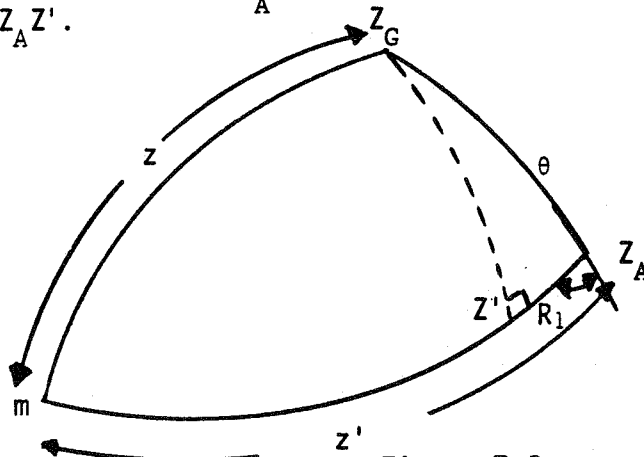

Figure 7.3
Determination of the Zenith Distances

Regarding the triangle Z_GZ_AZ' as a plane triangle, we have:

$$Z_AZ' = \theta \cos (180^\circ - R_1) = -\theta \cos R_1 \quad (7.29)$$

using R_1 from equation (7.11) and noting that $A-\gamma' = \alpha-\gamma$

$$Z_AZ' = -\theta \cos (A-\gamma') = -\theta \cos (\alpha-\gamma) \quad (7.30)$$

or expanding $\cos (\alpha-\gamma)$:

$$Z_AZ' = -\theta \cos \alpha \cos \gamma - \theta \sin \alpha \sin \gamma \quad (7.31)$$

Using equation (7.10) we may write (7.31) as:

$$Z_A Z' = z' - z = -(\xi \cos \alpha + \eta \sin \alpha) \quad (7.32)$$

The term $(\xi \cos \alpha + \eta \sin \alpha)$ is the component of the deflection of the vertical in the direction α . With equation (7.32) we can convert from a measured zenith distance z' , to a geodetic zenith distance z . Such a procedure is necessary when heights are being obtained by trigonometric levelling.

7.21 The Correction of Directions for Deflection of the Vertical Effects

In a triangulation network horizontal angles are measured with respect to the direction of the gravity vector at the point. What is wanted for actual applications are the corresponding directions with respect to the ellipsoid normal passing through the point. This requires a correction to the observed directions that will depend on the deflections of the vertical.

To derive this correction we consider equation (7.28) which is derived for azimuths. The term $-(\Lambda - \lambda) \sin \phi$ is constant at a given point as it depends only on Λ , λ and ϕ and is independent of direction. This term expresses the influence on the azimuth of the noncoincidence of the planes of the astronomic and geodetic meridian. The second term $-(\xi \sin \alpha - \eta \cos \alpha) \cot z$ expresses the influence on the measured direction of the non coincidence of the vertical axis of the instrument and the normal to the surface of the ellipsoid. It may thus be regarded as a correction due to the deflection of the vertical axis of the instrument from the normal to the surface of the given reference ellipsoid.

Let D be the corrected direction and D' the observed direction. We then write:

$$D = D' + \delta \quad (7.33)$$

where

$$\delta = -(\xi \sin \alpha - \eta \cos \alpha) \cot z \quad (7.34)$$

In most triangulation schemes we have noted that $\cot z$ would be close to zero and therefore the correction δ will be negligible. In mountainous areas z might reach 60° so that δ might reach several seconds of arc.

It is clear that to compute the direction correction, values of ξ and η are needed. The most direct way is to make astronomic measurements at all triangulation sites. However, this can be very expensive in terms of both time and manpower so that alternate techniques

may use existing deflections to predict the needed deflection at a specific site. Such a procedure is not simple as the deflections of the vertical are very much dependent on the terrain surrounding the station. Schwarz (1979) describes some general considerations on this problem for the United States.

7.22 The Extended Laplace Equation

The Laplace equation and the deflection of the vertical equations discussed in section 7.2 were based on the parallelity assumptions defined previously. For the analysis of existing networks, and for improved understanding of the problem it is helpful to have deflection of the vertical equations (including the Laplace azimuth equation) that does not have these assumptions.

This generalization has been discussed by Pick et al. (1973, p. 430), Grafarend and Richter (1977), Vincenty (1982) and others.

Let $\omega_x, \omega_y, \omega_z$ be small rotation angles describing the angular mis-orientation of the geodetic system with respect to the astronomic system. The rotation angles are positive in a clockwise direction when viewed from the axis origin. Under these circumstances the relationship between an astronomic azimuth and a geodetic azimuth can be written as (Vincenty, 1983, 01.20, private communication)

$$\alpha = A - \sin\alpha \cot z(\phi - \phi) - (\sin\phi - \cos\phi \cos\alpha \cot z)(\Lambda - \lambda) + a_1 \omega_x + a_2 \omega_y + a_3 \omega_z \quad (7.35)$$

The expressions for $a_1, a_2,$ and a_3 depend on the interpretation of the mis-orientation. The coefficients given in Table 1 of Grafarend and Richter (1977) assume a rotation of the astronomic reference system. Another interpretation considers a change not only in the astronomic system but also a resultant change in the geodetic coordinates. Clearly we also can consider changes in the astro geodetic deflections of the vertical as the coordinate system changes. For example the changes in the astronomic azimuth (dA), astronomic latitude ($d\phi$), and astronomic longitude ($d\Lambda$) caused by going from an old system to a new system would be (Vincenty, 1982, p. 240):

$$\begin{aligned} dA &= (\cos\lambda \omega_x + \sin\lambda \omega_y) / \cos\phi \\ d\phi &= -\sin\lambda \omega_x + \cos\lambda \omega_y \\ d\Lambda &= \tan\phi (\cos\lambda \omega_x + \sin\lambda \omega_y) - \omega_z \end{aligned} \quad (7.36)$$

The corresponding changes in the deflections of the vertical, if we assume no changes in the geodetic system, would be:

$$d\xi = d\phi$$

(7.37)

$$d\eta = d\Lambda \cos\phi$$

A more complete discussion of this problem is given in Vincenty (1983) and Vaniček and Carrera (1983).

7.3 Astro-Geodetic Undulations of the Geoid

In section 1 we briefly discussed the concept of the geoid as an irregular surface corresponding to mean sea level in the ocean areas and its extension into land areas. The location of the geoid with respect to some ellipsoid can be specified through the undulations of the geoid. We can also locate the geoid with respect to a specified ellipsoid of a specific geodetic datum using astro-geodetic deflections of the vertical.

In Figure 7.4 we sketch the geoid with respect to the ellipsoid of a geodetic datum.

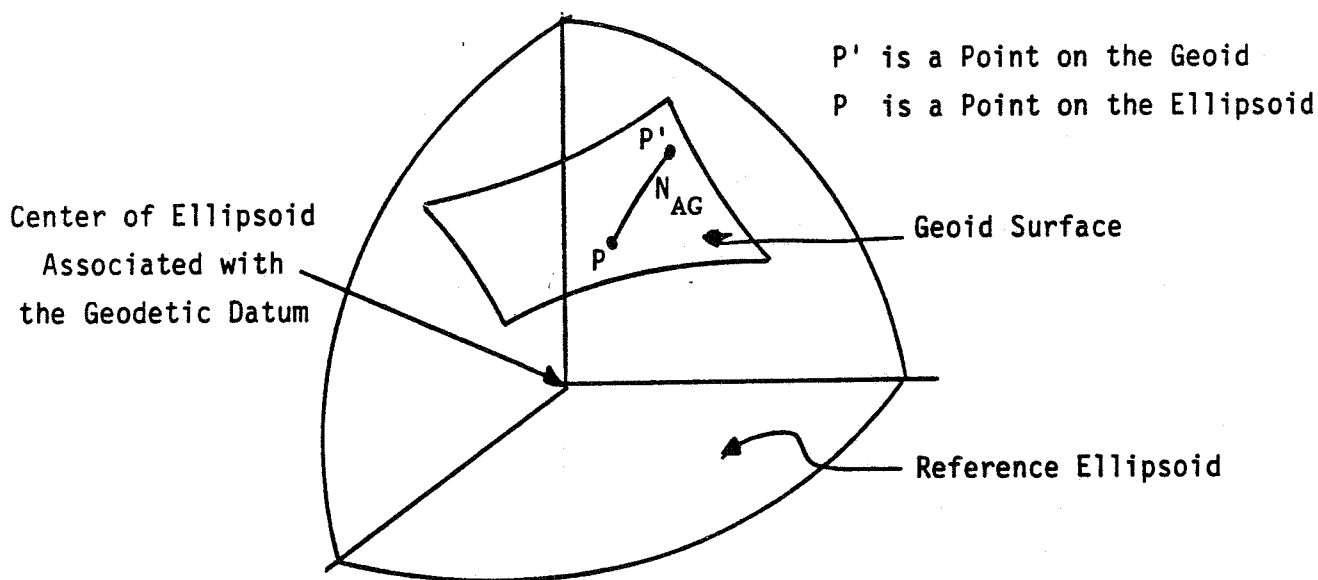

Figure 7.4
Location of the Geoid with Respect to the Reference Ellipsoid of a Specific Datum

In this figure P is a point on the ellipsoid and P' is a corresponding point on the geoid. The separation in a vertical direction between P and P' is the astro-geodetic undulation, N_{AG} . The quantity is positive when the geoid is outside the ellipsoid.

To compute astro-geodetic undulations we consider a geoid/ellipsoid profile in a direction defined by the azimuth α , as shown in Figure 7.5.

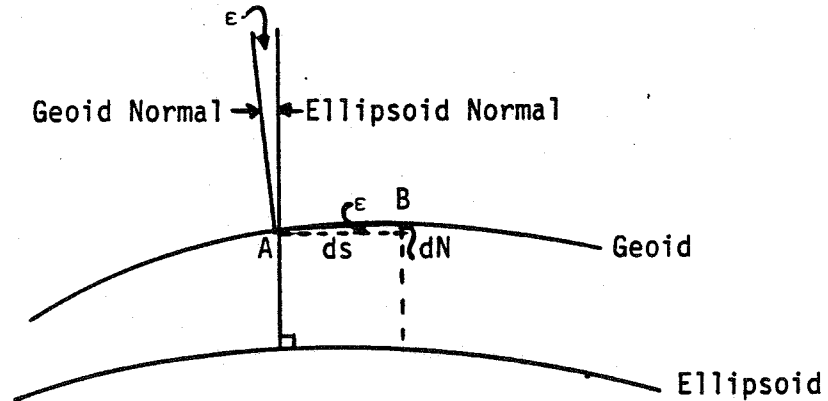

Figure 7.5
Astro-Geodetic Geoid Profile in Azimuth α

The angle at A between the ellipsoid normal and the gravity normal is the total deflection of the vertical, ϵ , in the direction of the section chosen. Let B be a point on the geoid, located a differential distance, ds , away from A. The change in the geoid undulation in going away from A to B is dN . From Figure 7.5 we can write:

$$\epsilon = -\frac{dN}{ds} \quad (7.38)$$

where the minus sign is a convention introduced to maintain consistency with the previous definitions of the astro geodetic deflections. We write (7.38) as:

$$dN = -\epsilon ds \quad (7.39)$$

where (from (7.32))

$$\epsilon = \xi \cos\alpha + \eta \sin\alpha \quad (7.40)$$

Now consider the integration of (7.39) from point A to some other point (D) in a network. We have from (7.39) and (7.40):

$$N_D - N_A = \int_A^D dN = -\int_A^D (\xi \cos\alpha + \eta \sin\alpha) ds \quad (7.41)$$

To evaluate (7.41) we need ξ and η along some path that connects points A and D. We note that (7.41) enables us to compute astro-geodetic undulation differences only. For an "absolute" undulation it is necessary that the undulation be defined at one point in the geodetic network. In a number of cases it is convenient to define the astro geodetic undulation to be zero at the origin point of the geodetic datum.

The actual implementation of (7.41) is done by numerical integration using neighboring stations. If we consider two stations i and j separated by a distance s_{ij} , with deflection components at each station, we can write (7.41) as:

$$N_{ij} = -\frac{s_{ij}}{2} ((\xi_i + \xi_j) \cos\alpha_{ij} + (\eta_i + \eta_j) \sin\alpha_{ij}) \quad (7.42)$$

In order to compute the astro-geodetic undulation in an area sense astro-geodetic profiles can be estimated and adjusted to form a consistent set of astro-geodetic undulations. For example consider the grid shown in Figure 7.6.

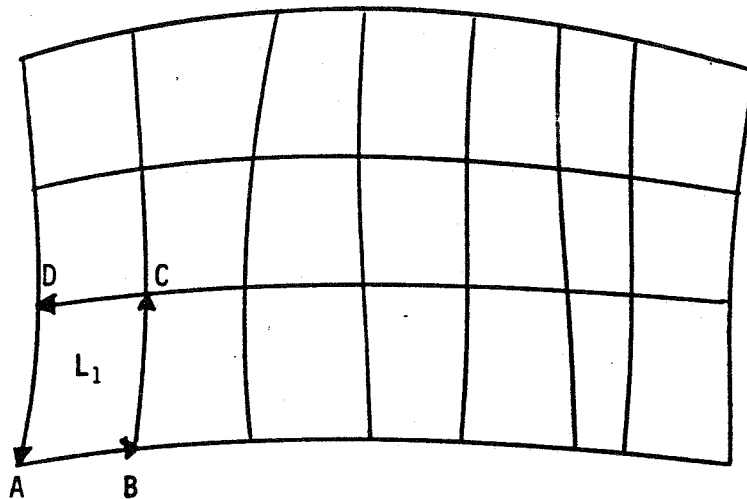

Figure 7.6
Astro-Geodetic Grid

At each point in the grid we might have astro-geodetic deflections that are used to compute undulation differences. In a loop such as L_1 the sum of the astro-geodetic undulations must be zero:

$$\sum_{L_1} N_{ij} = 0 \quad (7.43)$$

This type of condition can be used to form a set of condition equations, as is done in a levelling network adjustment, to obtain a unique, best estimate, set of astro-geodetic undulations. Such a procedure was essentially used by Fischer et al (1967) in producing astro-geodetic geoid charts of North and Central America. Carroll and Wessells (1975) describe a more recent astro-geodetic geoid for the United States. A smoothed version of this geoid based on a 15th degree polynomial function of latitude and longitude is shown in Figure 7.7. This map shows geoid undulations with respect to the North American Datum 1927. When the datum changes so will the astro-geodetic undulations.

In Figure 7.8 we show the astro-geodetic undulations of the geoid given with respect to the World Geodetic System 1972 (WGS72) (Seppelin, 1974b). Comparing Figures 7.7 and 7.8 reveal clearly the differences that are associated with the use of different geodetic datums.

The accuracy of the computation is based on several factors. One critical factor relates to the parallelity assumptions made in deriving the astro-geodetic deflection equations. If, for example, the initial meridians of the geodetic and astronomic systems are not parallel, a constant error in (primarily) η will occur which will cause errors in the astro-geodetic undulation differences computed from equation (7.42).

The accuracy of the ΔN computation will depend on the spacing of the astronomic stations along a profile. A typical spacing may be on the order of 20 km. However in mountainous regions this spacing may have to be reduced to 10-15 km to achieve an accuracy comparable to that in smooth areas. Based on loop closure analysis Bomford (1980, p. 366) reports the following accuracy estimates for ΔN determinations based on interpolation errors only:

<u>Area</u>	<u>Accuracy (S.D.) of ΔN</u>
Alps	$\pm 0.012 \sqrt{\lambda L}$ m
India	$\pm 0.00052 \sqrt{\lambda L}$ m
Finland	$\pm 0.00036 \sqrt{\lambda L}$ m

where λ is the average interval, in km, between astronomic stations, and L is the total length of the profile.

Other error sources include that associated with astronomic longitude and with geodetic position and determination. Robbins (1977) reported the following total ΔN errors for non-mountainous areas where deflections are determined to $\pm 0".7$ and the typical spacing is 25 km.

<u>m (ΔN)</u>	<u>Line Type</u>
$\pm 1.5 (L/1000)^{1/2}$ m	North-South
$\pm 1.9 (L/1000)^{1/2}$ m	East-West

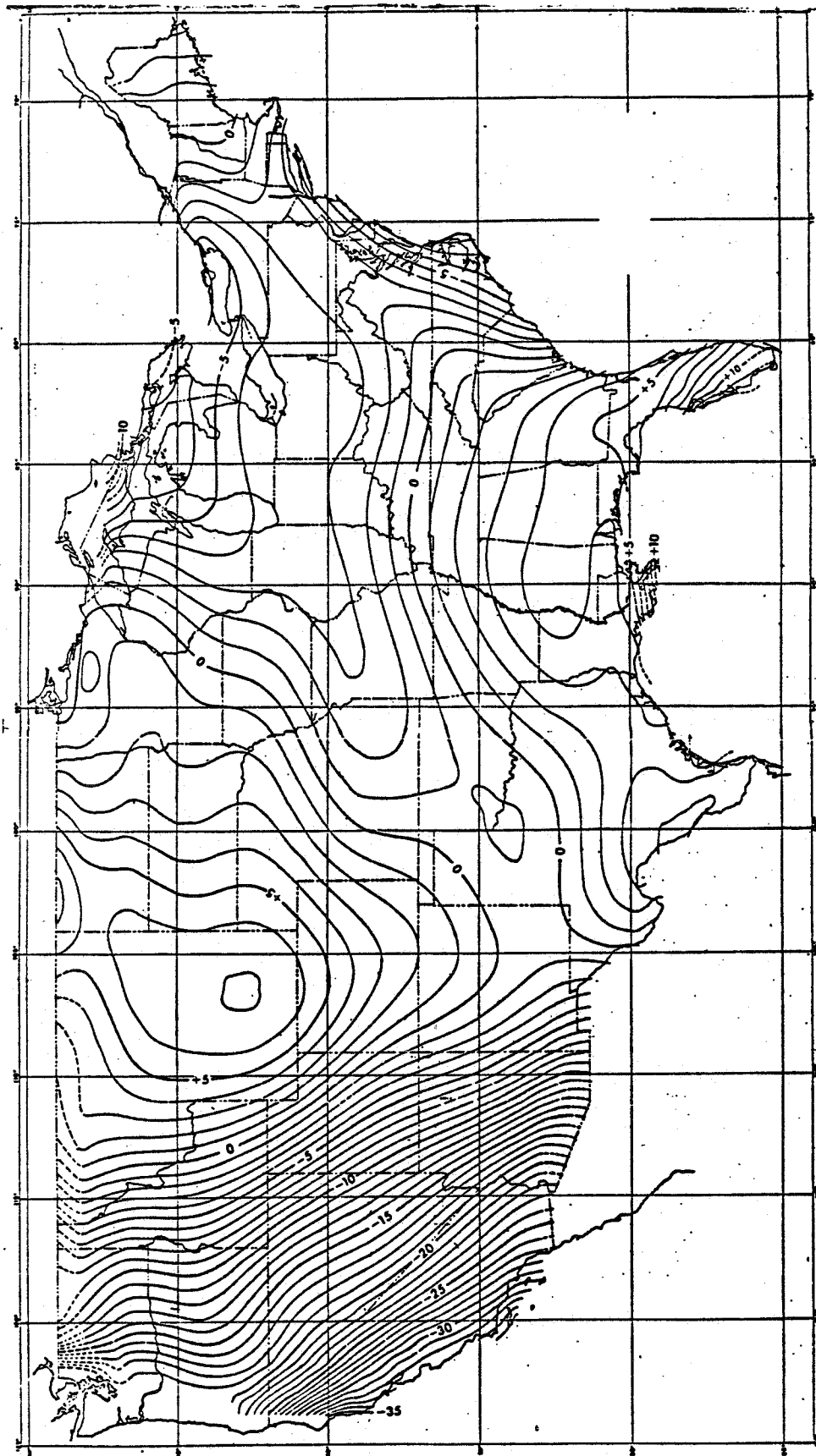

Figure 7.7
The Smoothed Astro-Geodetic Geoid in the United States
(from Carroll and Wessells, 1975)

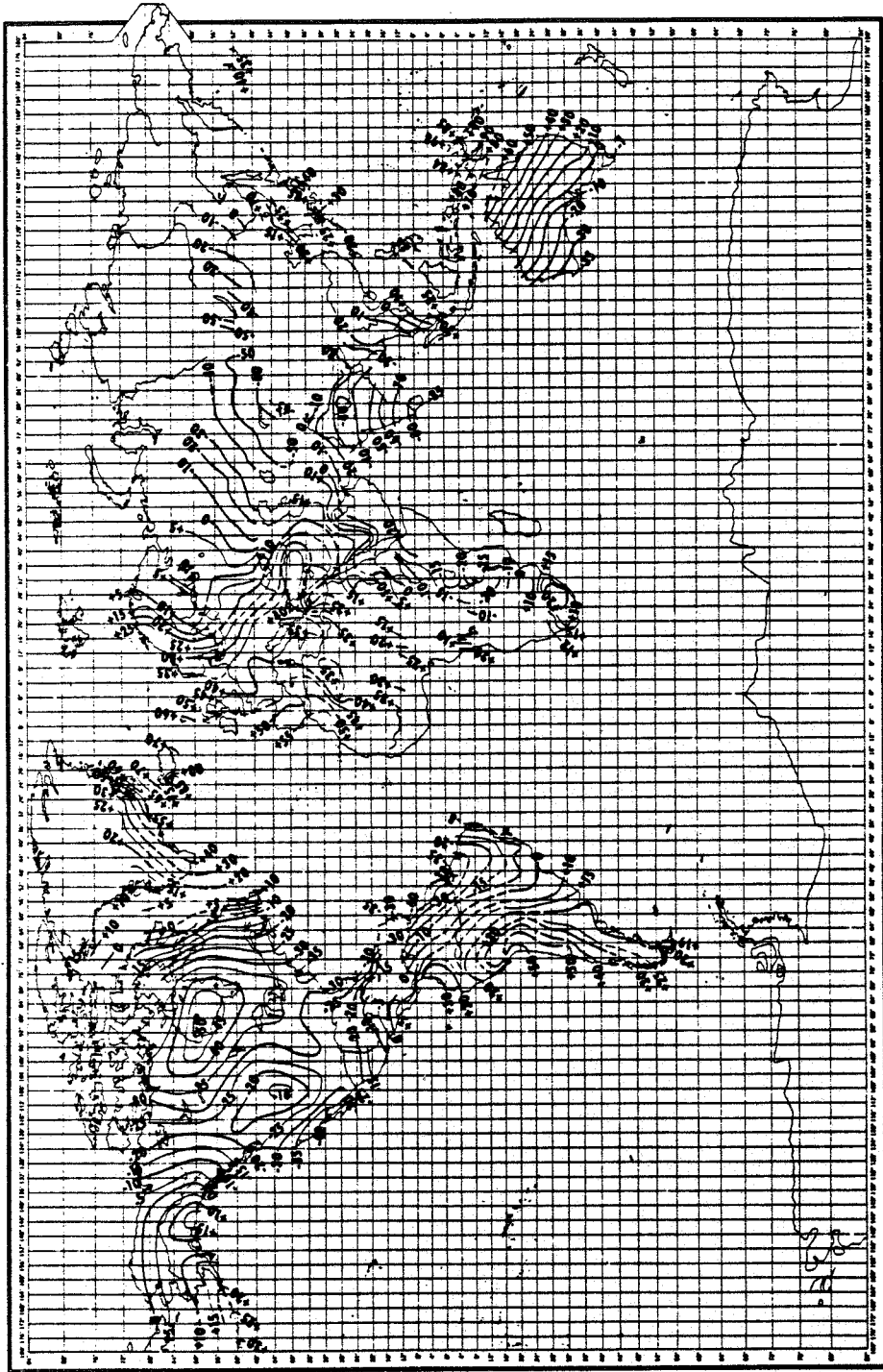

Figure 7.8
The Astro-Geodetic Geoid in Land Areas of the World Referred to the World Geodetic System 1972
(from Seppelin, 1974b)

For shorter lines better accuracy can be expected. Wenzel (1978), for example, gives the following accuracy estimate for N based on an analysis in the North Sea area:

$$m(\Delta N) = \pm 0.03 \sqrt{L} \text{ m} \quad (7.44)$$

where the typical station spacing was 10 km.

And finally we note that the astronomic quantities used for the deflection of the vertical computation must be quantities reduced to the geoid from the actual observation point; and the geodetic positions must be those referred to the ellipsoid based on the reduction of all measured data to the ellipsoid. If the latter procedure is not followed additional corrections must be made as described by Fischer (1967).

7.4 The Reduction of Measured Distances to the Ellipsoid

Distances that are measured in a geodetic network are usually reduced, at least in principle, to the ellipsoid on which the computations are made. Such a reduction is analogous to the correction of directions for deflection of the vertical discussed in section 7.21.

In this section we consider two reduction cases. The first case refers to the case of the reduction of base lines that have been measured with respect to the local vertical. The second case considers the reduction of chord distances measured with electronic distance measuring equipment which is independent of the direction of gravity.

To consider the first case we follow Heiskanen and Moritz (1967, p. 190). In Figure 7.9 we have a measured distance, $d\ell$, on the earth's surface. The inclination of the line with respect to the local horizon is β , and the deflection of the vertical in the direction (α) of the line is ϵ given by (7.40). The differential line element parallel to the ellipsoid is ds while the corresponding element on the ellipsoid is ds_0 . We approximate the ellipsoid by a sphere whose radius is the radius in direction α given by equation (3.104).

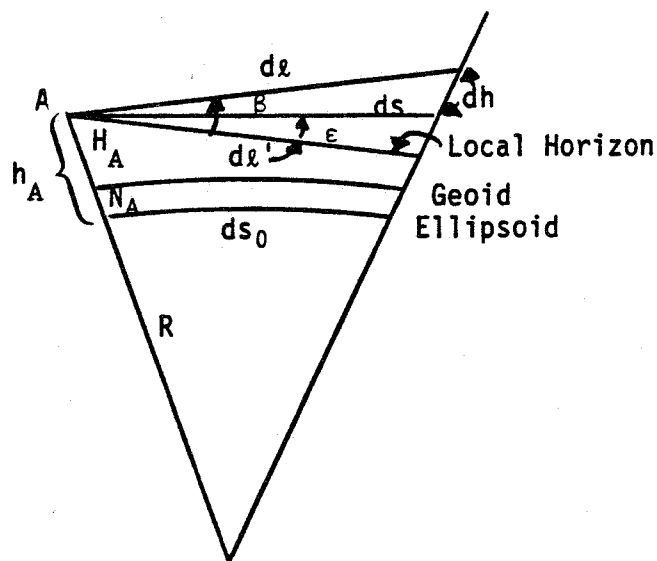

Figure 7.9
Baseline Reduction
(after Heiskanen and Moritz, 1967)

The value of ds is $d\ell$ projected on to the line parallel to the ellipsoid:

$$ds = d\ell \cos(\beta - \epsilon) = d\ell \cos\beta + \epsilon d\ell \sin\beta \quad (7.45)$$

Letting

$$d\ell' = d\ell \cos\beta$$

$$d\ell \sin\beta \approx dh$$

We can write (7.45) in the form:

$$ds = d\ell' + \epsilon dh \quad (7.46)$$

$d\ell'$ is the projection of $d\ell$ onto the local horizon. We now need to reduce ds to ds_0 which can be done by simple proportions:

$$\frac{ds}{ds_0} = \frac{R+h}{R} = 1 + \frac{h}{R} \quad (7.47)$$

where $h = H + N$ where H is the orthometric height (height above sea level) and N is the geoid undulation for the specified ellipsoid. Substituting (7.46) into (7.47) and retaining one term in the expansion of $(1 + h/R)$ we have:

$$ds_0 = ds - \frac{h}{R} ds_0 = d\ell' + \epsilon dh - \frac{h}{R} ds_0$$

or letting

$$d\psi = \frac{ds_0}{R} \quad (7.48)$$

we have

$$ds_0 = d\ell' + \epsilon dh - hd\psi = d\ell' + d(\epsilon h) - hd(\psi + \epsilon) \quad (7.49)$$

Now consider a line going from A to B. We integrate (7.49) between the two points to find:

$$s_0 = \ell' + \epsilon_B h_B - \epsilon_A h_A - \int_A^B hd(\psi + \epsilon) \quad (7.50)$$

If the height above the ellipsoid is taken as a constant h_m between A and B and using (7.48), (7.50) can be written as:

$$s_0 = \ell' + \epsilon_B h_B - \epsilon_A h_A - h_m (\epsilon_B - \epsilon_A) - \frac{h_m}{R} s_0 \quad (7.51)$$

where h_m is the mean elevation along the line. In (7.50) and (7.51) ℓ' is:

$$\ell' = \int_A^B d\ell \cos \beta \quad (7.52)$$

which is the sum of the horizontal components of a measured distance.

Equation (7.51) is the basic equation for the reduction of measured baselines. We note that the application of this formula requires information on the deflection of the vertical and the geoid undulation for proper reduction of the distances. In some applications the effect of the deflections have been inappropriately neglected. The effect of such neglect can be critical if the end point elevation differences are large and/or the deflections are significantly different at the end points of the lines.

The geometry of the second case of reduction is shown in Figure 7.10.

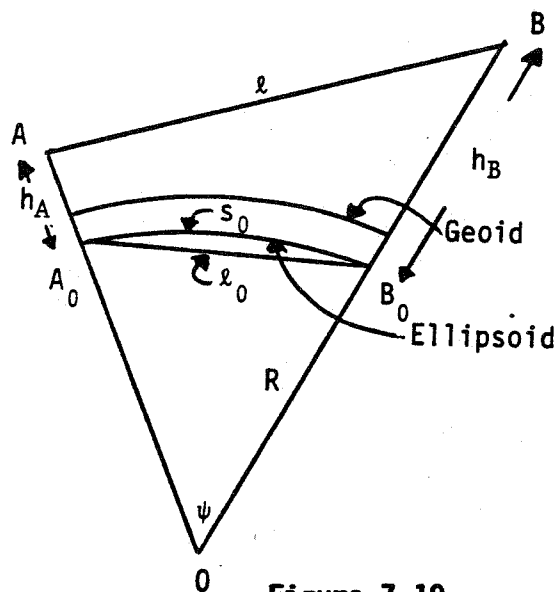

Figure 7.10
Reduction of Chord Distances to the Ellipsoid

In this figure the h value is the sum of the orthometric height plus the astro-geodetic undulation. The radius of the sphere, R , is $(R_A(\alpha) + R_B(\alpha))/2$. In this derivation we again follow Heiskanen and Moritz (1967, p. 192) and approximate the ellipsoid by a sphere of radius R in the azimuth α determined from (3.104). Using the law of cosines in triangle OAB we have:

$$\ell^2 = (R+h_A)^2 + (R+h_B)^2 - 2(R+h_A)(R+h_B) \cos \psi \quad (7.53)$$

If we use the identity

$$\cos \psi = 1 - 2 \sin^2 \frac{\psi}{2} \quad (7.54)$$

we can write (7.53) in the form:

$$\ell^2 = (h_B - h_A)^2 + 4R^2 \left(1 + \frac{h_A}{R}\right) \left(1 + \frac{h_B}{R}\right) \sin^2 \frac{\psi}{2} \quad (7.55)$$

Now the corresponding chord distance between the points reduced to the ellipsoid would be:

$$\ell_0 = 2R \sin \frac{\psi}{2} \quad (7.56)$$

which can be used in (7.55) to write (with $\Delta h = h_B - h_A$):

$$\ell^2 = \Delta h^2 + \left(1 + \frac{h_A}{R}\right) \left(1 + \frac{h_B}{R}\right) \ell_0^2 \quad (7.57)$$

Solving for ℓ_0 we have:

$$\ell_0 = \sqrt{\frac{\ell^2 - \Delta h^2}{\left(1 + \frac{h_A}{R}\right) \left(1 + \frac{h_B}{R}\right)}} \quad (7.58)$$

We now can use equations such as (4.57) or (4.58) to reduce the chord distance to the distance, s_0 , on the ellipsoid.

The accuracy of equation (7.58) has been studied by Thomson and Vanicek (1974) and found to be adequate for all practical purposes. Vincenty (1975) has also considered the reduction of spatial distances to the ellipsoid incorporating deflections of the vertical to obtain astro-geodetic undulation differences.

8. DIFFERENTIAL FORMULAS OF THE FIRST AND SECOND TYPE

For applications such as the formation of observation equations for triangulation and trilateration adjustment, and for the formation of equations useful in the determination of the size and the shape of the earth, it is necessary to obtain equations relating differential changes in various quantities. Such equations are divided into two types.

Differential formulas of the first type (or kind) are those which give changes in the geodetic coordinates and directions as a function of the starting coordinates and azimuth of a line. Differential formulas of the second type (or kind) are those which give corrections for coordinates and directions resulting from changes in the equatorial radius and a shape defining parameter such as the flattening.

Discussions of these differential formulas may be found in Bagratuni (1967, p. 280), Jordan (Volume III, second half, p. 439), Zakatov (1962, p. 104), Grushinskiy (1969, p. 84), and Tobey (1927).

8.1 Differential Formulas of the First Type

We assume that we have computed the coordinates ϕ_2, λ_2 and back azimuth α_{21} of a point P_2 based on the coordinates ϕ_1, λ_1 of the first point P_1 , and a distance s and azimuth α_{12} . We now wish to find the change in ϕ_2, λ_2 and α_{21} if we change $\phi_1, \lambda_1, \alpha_{12}$, and s . We may express this analytically by writing the following:

$$d\phi_2 = \frac{\partial\phi_2}{\partial\phi_1} d\phi_1 + \frac{\partial\phi_2}{\partial s} ds + \frac{\partial\phi_2}{\partial\alpha_{12}} d\alpha_{12} \quad (8.1)$$

$$d\lambda_2 = \frac{\partial\lambda_2}{\partial\phi_1} d\phi_1 + \frac{\partial\lambda_2}{\partial s} ds + \frac{\partial\lambda_2}{\partial\alpha_{12}} d\alpha_{12} + d\lambda_1 \quad (8.2)$$

$$d\alpha_{21} = \frac{\partial\alpha_{21}}{\partial\phi_1} d\phi_1 + \frac{\partial\alpha_{21}}{\partial s} ds + \frac{\partial\alpha_{21}}{\partial\alpha_{12}} d\alpha_{12} \quad (8.3)$$

We note that in equations (8.1) and (8.3) no longitude term appears. This is because of the rotational symmetry of the reference ellipsoid. For convenience, equations (8.1), (8.2), and (8.3) are written in the following form:

$$d\phi_2 = d\phi_2^{\phi_1} + d\phi_2^s + d\phi_2^{\alpha_{12}} \quad (8.4)$$

$$d\lambda_2 = d\lambda_1 + d\lambda_2^{\phi_1} + d\lambda_2^s + d\lambda_2^{\alpha_{12}} \quad (8.5)$$

$$d\alpha_{21} = d\alpha_{21}^{\phi_1} + d\alpha_{21}^s + d\alpha_{21}^{\alpha_{12}} \quad (8.6)$$

The derivation of these equations is simple for some cases and more complex for others. The various authors previously mentioned have each obtained different solutions to this problem. Bagratuni and Jordan have given the most rigorous expressions. Zakatov and Grushinskiy give similar results, but certain terms in a slightly different fashion.

We now derive some of the terms given in equations (8.4, 5, and 6). We first consider the effect of extending a geodesic of length s by a differential length ds . The effect of this extension on moving point F to F_2 is shown in Figure 8.1.

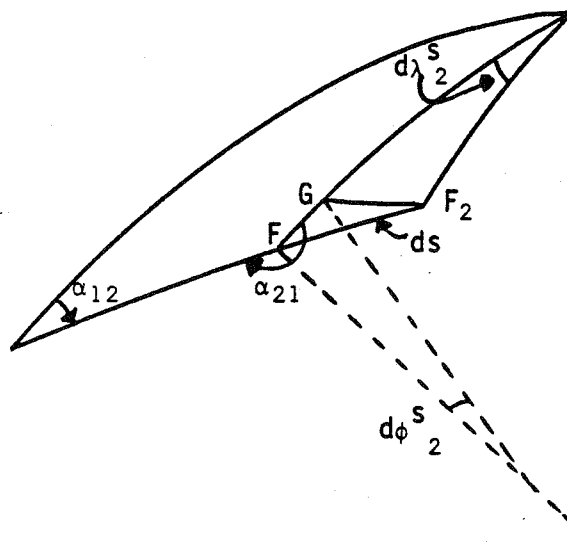

Figure 8.1
The Differential Effect of a Length Extension

G is a point on the meridian through F and on the parallel through F_2 . We have:

$$FG = ds \cos (\alpha_{21} - 180^\circ) \quad (8.7)$$

$$FG = -ds \cos \alpha_{21}$$

We also have:

$$FG = M_2 d\phi_s^s \quad (8.8)$$

Equating equations (8.7) and (8.4) we have:

$$d\phi_s^s = \frac{-\cos \alpha_{21} ds}{M_2} \quad (8.9)$$

Next we compute GF_2 as:

$$GF_2 = ds \sin (\alpha_{21} - 180^\circ) = -\sin \alpha_{21} ds \quad (8.10)$$

We also have GF_2 as:

$$GF_2 = N_2 \cos \phi_2 d\lambda_2^s \quad (8.11)$$

Equating equations (8.10) and (8.11) we have:

$$d\lambda_2^s = \frac{-\sin \alpha_{21} ds}{N_2 \cos \phi_2} \quad (8.12)$$

To obtain the change in back azimuth we recall Clairaut's equation (4.81) for a geodesic written in the following form:

$$N_2 \cos \phi_2 \sin (\alpha_{21} - 180^\circ) = \text{a constant} = c$$

or (8.13)

$$N_2 \cos \phi_2 \sin \alpha_{21} = -c = c'$$

We differentiate this expression assuming all quantities are variables. Thus:

$$N_2 \cos \phi_2 \cos \alpha_{21} d\alpha_{21} + d(N_2 \cos \phi_2) \sin \alpha_{21} = 0 \quad (8.14)$$

Carrying out the differentiation of $N_2 \cos \phi_2$ we find:

$$d(N_2 \cos \phi_2) = -M_2 \sin \phi_2 d\phi_2 \quad (8.15)$$

With this latter expression substituted into equation (8.14) and a solution made for $d\alpha_{21}$ we have:

$$d\alpha_{21} = \tan \alpha_{21} \tan \phi_2 \frac{M_2}{N_2} d\phi_2 \quad (8.16)$$

Up to this point equation (8.16) is a general equation in the sense of a $d\phi_2$ change yielding a $d\alpha_{21}$ change. If we are interested in the effect of ds on $d\alpha_{21}$, we substitute equation (8.9) into (8.16) to obtain:

$$d\alpha_{21} = \frac{-\sin\alpha_{21} \tan\phi_2}{N_2} ds \quad (8.17)$$

We next consider the various effects when the azimuth at the first point is changed by an amount $d\alpha_{12}$. This situation is shown in Figure 8.2 where point F is the original end point of the line and F_2 is its end point after rotation.

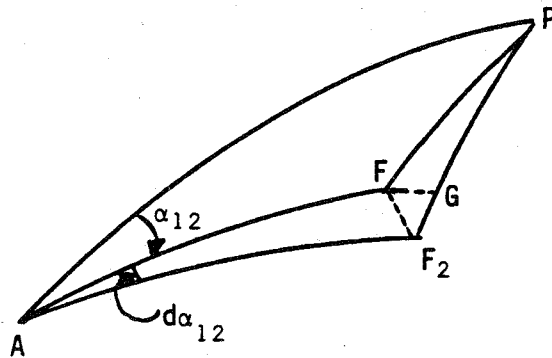

Figure 8.2
The Differential Effect of an Azimuth Change

In Figure 8.2 we have drawn the arc FG such that it is perpendicular to the meridian through F_2 . In addition, due to the rotation, angle FF_2A will be close to a right angle so that angle GF_2F will be $270^\circ - \alpha_{21}$. Then we see from the figure that:

$$GF_2 = FF_2 \cos GF_2 F = FF_2 \cos(270^\circ - \alpha_{21}) = -FF_2 \sin\alpha_{21} \quad (8.18)$$

However from the discussion in Section 4.22 we have:

$$FF_2 = w d\alpha_{12} \quad (8.19)$$

which may be substituted into (8.18) to write:

$$GF_2 = -w \sin\alpha_{21} d\alpha_{12} \quad (8.20)$$

The side GF_2 may also be expressed as:

$$-M_2 d\phi_2^{\alpha_{12}} \quad (8.21)$$

where the minus sign arises from the fact that an increase of α_{12} will cause a decrease in the latitude.

Equating equations (8.21) and (8.20) and solving for $d\phi_2^{\alpha_{12}}$ we have:

$$d\phi_2^{\alpha_{12}} = w \frac{\sin \alpha_{21}}{M_2} d\alpha_{12} \quad (8.22)$$

In order to find the change in longitude due to this rotation, we express FG as follows:

$$FG = FF_2 \sin FF_2 G = FF_2 \sin(270^\circ - \alpha_{21}) = -FF_2 \cos \alpha_{21} \quad (8.23)$$

Using equation (8.19) for FF_2 , and noting that:

$$FG = N_2 \cos \phi_2 d\lambda_2^{\alpha_{12}} \quad (8.24)$$

we can find $d\lambda_2^{\alpha_{12}}$ to obtain:

$$d\lambda_2^{\alpha_{12}} = \frac{-w \cos \alpha_{21}}{N_2 \cos \phi_2} d\alpha_{12} \quad (8.25)$$

We now turn to the derivation of the change of the back azimuth α_{21} caused by $d\alpha_{12}$. To do this we consider Figure 8.3:

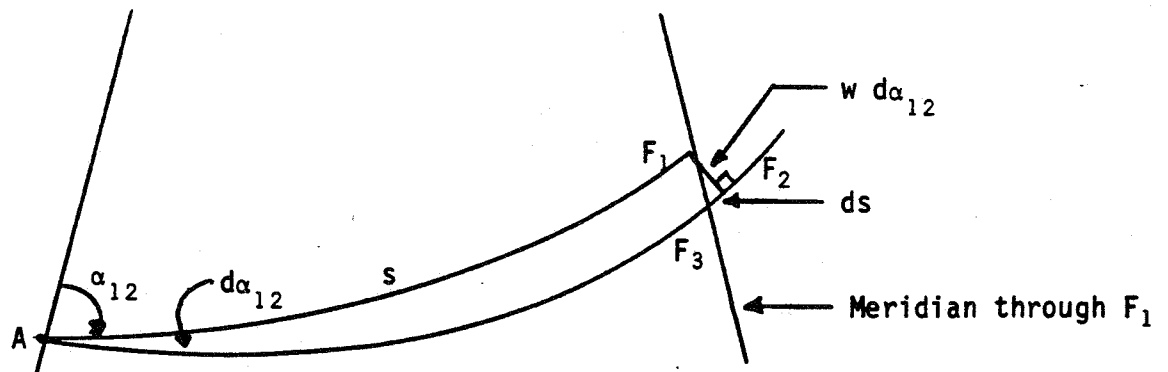

Figure 8.3
The Back Azimuth Change due to $d\alpha_{12}$

In this figure: F_1 = original end point of the line
 F_2 = new end point after rotation $d\alpha_{12}$
 F_3 = point on AF_2 on meridian through F_1

Now let $d\alpha_{21} = d\alpha_2$ where α_2 is the forward azimuth at point 2 (i.e. F_1). For the moment we designate the total change in $d\alpha_2$ as $d\alpha_{2r}$. We will consider it composed of two changes ($d\alpha_{2m}$ and $d\alpha_{2e}$). Let $d\alpha_{2m}$ be the change in α_{21} as F_1 approaches F_2 . Now we also consider a special change in $d\alpha_2$ when F_2 is displaced by $ds = F_2F_3$ to F_3 . We define this to be $d\alpha_{2e}$. We can note that the value of $d\alpha_{2r}$ is simply the sum of the corrections:

$$d\alpha_{2r} = d\alpha_{2m} + d\alpha_{2e} \quad (8.26)$$

To find $d\alpha_{2m}$ we note that it is simply the change in back azimuth as we move along a meridian.

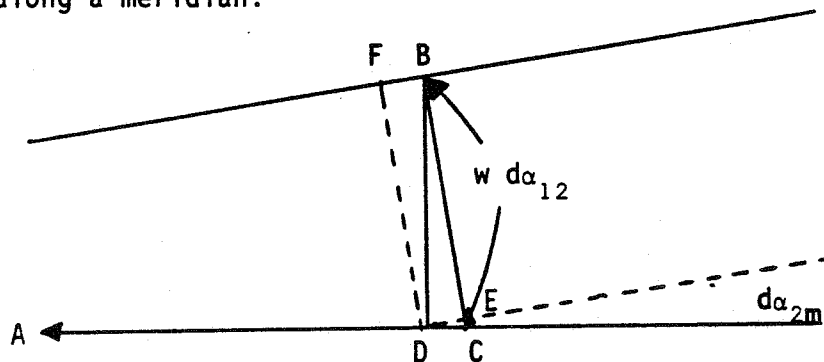

Figure 8.4
Detailed Back Azimuth Change Effects

We have:

- B = original endpoint
- C = end point after rotation of $d\alpha_{12}$
- D = point on meridian through B, on line AC
- F = point on original line determined by a line parallel to BC
- E = point on a line parallel to FB through D

Now DC represents a distance change caused by the rotation. If $d\alpha_{12}$ is positive ds is negative. For ease, we work with forward azimuths. At B the forward azimuth is FBD, while at D it is CDB. The difference is the required change:

$$d\alpha_{2m} = CDB - FBD = EDC$$

We have:

$$d\alpha_{2m} = \frac{CE}{DC} \quad \text{where } CE = BC - DF \text{ and } DC = -ds$$

so that:

$$d\alpha_{2m} = \frac{BC - DF}{-ds}$$

Using the definition of w we have:

$$BC = w d\alpha_{12}$$

If we note that in going from B to F w will now be $w + dw$ (dw will be negative) we can also write:

$$DF = (w + dw) d\alpha_{12}$$

Thus:

$$d\alpha_{2m} = \frac{w d\alpha_{12} - (w + dw) d\alpha_{12}}{-ds} \quad (8.27)$$

Equation (8.27) is valid for point movement along a meridian. In our particular case, (8.27) is needed in (8.26) as $d\alpha_{2m}$. We now require $d\alpha_{2e}$ which is simply equation (8.17):

$$d\alpha_{2e} = \frac{-ds \tan\phi_2 \sin\alpha_{21}}{N_2} \quad (8.28)$$

In this case $ds = F_2 F_3$ and is written as:

$$ds = w d\alpha_{12} \cot\alpha_{21} \quad (8.29)$$

Combining (8.29), (8.28), (8.27) into (8.26) we may write:

$$d\alpha_2 = \left(\frac{dw}{ds} - \frac{w \tan\phi_2 \cos\alpha_{21}}{N_2} \right) d\alpha_{12} \quad (8.30)$$

Recall that this equation yields change in the back azimuth at the second point caused by an azimuth change at the first point since $d\alpha_2 = d\alpha_{21}$. The value of dw/ds could be found by differentiating equation (4.103). This would yield a series expression so that it is convenient to formulate another approach. Recall that:

$$N_2 \cos\phi_2 \sin\alpha_2 = N_1 \cos\phi_1 \sin\alpha_{12} = -N_2 \cos\phi_2 \sin\alpha_{21} \quad (8.31)$$

We differentiate this using the results given in (8.15), recognizing that ϕ_1 is a constant. Then:

$$-N_2 \cos\phi_2 \cos\alpha_{21} d\alpha_2 + M_2 \sin\phi_2 \sin\alpha_{21} d\phi_2 = N_1 \cos\phi_1 \cos\alpha_{12} d\alpha_{12} \quad (8.32)$$

Now we use the value of $d\phi_2$ from (8.22) in the above equation to find:

$$d\alpha_2 = \left[\frac{-N_1 \cos\phi_1 \cos\alpha_{12}}{N_2 \cos\phi_2 \cos\alpha_{21}} + \frac{w \tan\phi_2 \tan\alpha_{21} \sin\alpha_{21}}{N_2} \right] d\alpha_{12} \quad (8.32a)$$

Since the two expressions (8.30) and (8.32a) are the same we can solve for dw/ds to find:

$$\frac{dw}{ds} = \left(\frac{-N_1 \cos\phi_1 \cos\alpha_{12}}{N_2 \cos\phi_2 \cos\alpha_{21}} + \frac{w \tan\phi_2}{N_2 \cos\alpha_{21}} \right) \quad (8.33)$$

The derivations described in the last few pages represent only a portion of the ones needed for equations (8.4, 5, 6). We choose not to continue these derivations, but to now summarize the changes we have derived and to give others, not derived, but that may be found in the literature. We have:

$$d\phi_2^{\phi_1} = \frac{-M_1}{M_2} [\sin\alpha_{12} \sin\alpha_{21} \left(\frac{dw}{ds}\right)_2 + \cos\alpha_{12} \cos\alpha_{21}] d\phi_1, \quad (\text{Jordan, p.441})$$

$$d\phi_2^s = \frac{-\cos\alpha_{21}}{M_2} ds; \quad (\text{our 8.9})$$

$$d\phi_2^{\alpha_{12}} = \frac{w}{M_2} \sin\alpha_{21} d\alpha_{12}; \quad (\text{our 8.22})$$

$$d\lambda_2^{\phi_1} = \frac{M_1}{N_2 \cos\phi_2} [\sin\alpha_{12} \cos\alpha_2 \left(\frac{dw}{ds}\right)_2 - \cos\alpha_{12} \sin\alpha_2] d\phi_1, \quad (\text{Jordan, p. 442})$$

$$d\lambda_2^s = \frac{-\sin\alpha_{21}}{N_2 \cos\phi_2} ds; \quad (\text{our 8.12})$$

$$d\lambda_2^{\alpha_{12}} = \frac{-w \cos\alpha_{21}}{N_2 \cos\phi_2} d\alpha_{12}; \quad (\text{our 8.25})$$

$$\begin{aligned}
d\alpha_{21}^{\phi_1} &= \left(\frac{M_1}{w} \sin\alpha_{12} - \frac{M_1}{N_2} \sin\alpha_2 \cos\alpha_{12} \tan\phi_2 \right. \\
&\quad \left. - \frac{M_1}{w} \left(\frac{dw}{ds} \right)_1 \left(\frac{dw}{ds} \right)_2 \sin\alpha_1 \right. \\
&\quad \left. + \frac{M_1}{N_2} \left(\frac{dw}{ds} \right)_2 \sin\alpha_1 \cos\alpha_2 \tan\phi_2 \right) d\phi_1, \quad (\text{Jordan, p. 442})
\end{aligned}$$

$$d\alpha_{21}^s = \frac{-\sin\alpha_{21} \tan\phi_2}{N_2} ds; \quad (\text{our 8.17})$$

$$\begin{aligned}
d\alpha_{21}^{\alpha_{12}} &= \left[\frac{-N_1 \cos\phi_1 \cos\alpha_{12}}{N_2 \cos\phi_2 \cos\alpha_{21}} + \frac{w \tan\phi_2 \tan\alpha_{12} \sin\alpha_{21}}{N_2} \right] \cdot d\alpha_{12}; \\
&\hspace{15em} (\text{our 8.32})
\end{aligned}$$

or

$$d\alpha_{21}^{\alpha_{12}} = \left(\frac{dw}{ds} - \frac{w \tan\phi_2 \cos\alpha_{21}}{N_2} \right) d\alpha_{12}; \quad (\text{our 8.30}).$$

The above equation summary will be referred to as equation (8.34).

8.2 Differential Formulas of the Second Type

In order to determine the influence of change in ellipsoid parameters on coordinate and direction computations we can differentiate any of the equations derived for the direct problem such as (6.19) (the Legendre series) or the Puissant equations such as are given in equation (6.40). For convenience we choose to use equations (6.19) retaining the first terms only and letting the evaluations take place at a mean latitude. We then write:

$$(\phi_2 - \phi_1) = \frac{V^3}{c} \cos\alpha \Big|_m s = \frac{\cos\alpha_{12}}{M_m} s = \frac{s \cos\alpha_{12} (1 - e^2 \sin^2\phi_m)^{3/2}}{a(1 - e^2)} \quad (8.35)$$

$$(\lambda_2 - \lambda_1) = \frac{V}{c} \frac{\sin\alpha}{\cos\phi} \Big|_m s = \frac{\sin\alpha_{12}}{N_m \cos\phi_m} s = \frac{s \sin\alpha_{12} (1 - e^2 \sin^2\phi_m)^{1/2}}{a \cos\phi_m} \quad (8.36)$$

$$(\alpha_{21} - \alpha_{12}) - 180^\circ = \frac{V}{c} \sin\alpha \tan\phi \Big|_m s = \frac{s \sin\alpha_{12} \tan\phi_m}{N_m} = (\lambda_2 - \lambda_1) \sin\phi_m \quad (8.37)$$

We first differentiate equation (8.35) with respect to a and e^2 . We have:

$$d(\phi_2 - \phi_1) = s \cos \alpha_{12} \left[\frac{-1}{a^2} \frac{(1-e^2 \sin^2 \phi_m)^{3/2}}{(1-e^2)} da + \frac{1}{a} \cdot \left(-\frac{3}{2} \sin^2 \phi_m \frac{(1-e^2 \sin^2 \phi_m)^{1/2}}{(1-e^2)} + \frac{(1-e^2 \sin^2 \phi_m)^{3/2}}{(1-e^2)^2} \right) de^2 \right] \quad (8.38)$$

which may be written in the form:

$$d(\phi_2 - \phi_1) = \frac{s \cos \alpha_{12} (1-e^2 \sin^2 \phi_m)^{3/2}}{a (1-e^2)} \left[\frac{-da}{a} + \left(-\frac{3}{2} \sin^2 \phi_m \cdot \frac{1}{(1-e^2 \sin^2 \phi_m)} + \frac{1}{1-e^2} \right) de^2 \right] \quad (8.39)$$

We note that the first term on the right hand side of (8.39) is simply $(\phi_2 - \phi_1)$ as given by equation (8.35). To transform (8.39) into a simpler form we recall that $e^2 = 2f - f^2$ so that

$$de^2 = 2(1-f) df \approx 2df \quad (8.40)$$

Substituting the approximation of (8.40) into (8.39), and using equation (8.35) we have:

$$d(\phi_2 - \phi_1) = -(\phi_2 - \phi_1) \left[\frac{da}{a} \left[\frac{2}{1-e^2} - \frac{3 \sin^2 \phi_m}{(1-e^2 \sin^2 \phi_m)} \right] df \right] \quad (8.41)$$

Setting the $(1-e^2)$ and $(1-e^2 \sin^2 \phi_m)$ that appear on the right hand side of equation (8.41) to one, we finally have:

$$d(\phi_2 - \phi_1) = -(\phi_2 - \phi_1) \left[\frac{da}{a} - (2 - 3 \sin^2 \phi_m) df \right] \quad (8.42)$$

We next differentiate equation (8.36) with respect to a and e^2 . We have at the start:

$$d(\lambda_2 - \lambda_1) = \frac{s \sin \alpha_{12}}{\cos \phi_m} \left[\frac{-(1-e^2 \sin^2 \phi_m)^{1/2} da}{a^2} - \frac{\sin^2 \phi_m (1-e^2 \sin^2 \phi_m)^{-1/2}}{2a} de^2 \right] \quad (8.43)$$

Simplifying we have:

$$d(\lambda_2 - \lambda_1) = \frac{-s \sin \alpha_{12}}{a \cos \phi_m} (1-e^2 \sin^2 \phi_m)^{1/2} \left[\frac{da}{a} + \frac{\sin^2 \phi_m}{2(1-e^2 \sin^2 \phi_m)} de^2 \right] \quad (8.44)$$

Noting that the first term on the right side of equation (8.44) is the same as equation (8.36), letting $de^2=2df$, and setting the term $(1-e^2\sin^2\phi_m)$ to one, equation (8.44) may be written:

$$d(\lambda_2-\lambda_1) = -(\lambda_2-\lambda_1) \left[\frac{da}{a} + \sin^2\phi_m df \right] \quad (8.45)$$

To find the effect on the back azimuth, we first differentiate equation (8.37) in the following form:

$$d\alpha_{21} = d(\lambda_2-\lambda_1) \sin\phi_m \quad (8.46)$$

Then, using equation (8.45) for $d(\lambda_2-\lambda_1)$ we have:

$$d\alpha_{21} = -(\lambda_2-\lambda_1) \sin\phi_m \left[\frac{da}{a} + \sin^2\phi_m df \right] \quad (8.47)$$

We note that the first terms on the right side of equation (8.47) is the total azimuth change, $d\alpha$, in moving from point one to point two.

The above derivations have been carried out with several approximations. Consequently the equations are only valid for lines up to 40-50 km for an accuracy of ".001-.002. In order to derive more exact expressions it is convenient to differentiate the extended power series formulas such as given in equation (6.19). The results of such derivations are given in Bagratuni (1967, p. 286):

$$\begin{aligned} d(\phi_2-\phi_1) = & -[(\phi_2-\phi_1) - \frac{3}{2} \tan\phi_m \eta^2 (\phi_2-\phi_1)^2 - \frac{V^2 \cos^2\phi_m \tan\phi_m}{2} (\lambda_2-\lambda_1)^2] \frac{da}{a} \\ & + [(\phi_2-\phi_1) \cos^2\phi_m (2-t^2+\eta^2 + \frac{7}{2} \eta^2 \tan^2\phi_m) - \frac{3(\phi_2-\phi_1)^2 \cos^2\phi_m \tan\phi_m}{2} \\ & \cdot (2-2\eta^2+2t^2\eta^2) + \frac{(\lambda_2-\lambda_1)^2 \cos^4\phi_m \tan\phi_m}{2} (\tan^2\phi_m + \frac{1}{2} \eta^2 \tan^2\phi_m + \\ & + \frac{1}{2} \eta^2 \tan^4\phi_m)] df \end{aligned} \quad (8.48)$$

$$\begin{aligned} d(\lambda_2-\lambda_1) = & -[(\lambda_2-\lambda_1) + (\lambda_2-\lambda_1)(\phi_2-\phi_1) \tan\phi_m (1-\eta^2)] \frac{da}{a} \\ & - [(\lambda_2-\lambda_1) \cos^2\phi_m (\tan^2\phi_m - \frac{1}{2} \eta^2 \tan^2\phi_m + \frac{1}{2} \eta^2 \tan^4\phi_m) + (\lambda_2-\lambda_1)(\phi_2-\phi_1) \\ & : \cos^2\phi_m \tan\phi_m (\tan^2\phi_m - \frac{3}{2} \eta^2 \tan^2\phi_m + \frac{1}{2} \eta^2 \tan^4\phi_m)] df \end{aligned} \quad (8.49)$$

$$\begin{aligned}
d(\alpha_{21}) &= -[(\lambda_2 - \lambda_1) \cos \phi_m \tan \phi_m + (\lambda_2 - \lambda_1)(\phi_2 - \phi_1) \cos \phi_m (1 + \tan^2 \phi_m - \eta^2 \tan^2 \phi_m)] \\
&\cdot \frac{da}{a} - [(\lambda_2 - \lambda_1) \cos^3 \phi_m \tan \phi_m (\tan^2 \phi_m - \frac{1}{2} \eta^2 \tan \phi_m + \frac{1}{2} \eta^2 \tan^4 \phi_m) \quad (8.50) \\
&- (\phi_2 - \phi_1)(\lambda_2 - \lambda_1) \cos^3 \phi_m (1 - \tan^2 \phi_m - \tan^4 \phi_m + \frac{1}{2} \eta^2 + 2\eta^2 t^2)] df
\end{aligned}$$

This concludes the discussion on differential formulas of the first and second kind. We will see in the next section how the formulas of the first kind can be used to develop triangulation/trilateration observation equations.

9. OBSERVATION EQUATIONS FOR TRIANGULATION, TRILATERATION COMPUTATIONS ON THE ELLIPSOID

The equations discussed in section 8 enable us to develop observation equations for use with azimuth (or direction) and distance measurements made for conventional horizontal control. Specifically we now need to develop equations that relate changes in the azimuth and distance between two points to the corresponding changes of the geodetic coordinates. Our discussion follows closely that of Tobey (1928).

9.1 Direction and Distance Relationships

We first consider the change in latitude of a second point, caused by a distance change (ds) and an azimuth change $d\alpha_{12}$ at the first point. From equations (8.9) and (8.22) we can write the total effect of these two changes as follows:

$$d\phi_2 = \frac{w \sin\alpha_{21}}{M_2} d\alpha_{12} - \frac{\cos\alpha_{21}}{M_2} ds \quad (9.1)$$

The corresponding effect on longitude is:

$$d\lambda_2 = \frac{-w \cos\alpha_{21}}{N_2 \cos\phi_2} d\alpha_{12} - \frac{\sin\alpha_{21}}{N_2 \cos\phi_2} ds \quad (9.2)$$

Using equation (8.17) and (8.30) the total change in α_{21} will be:

$$d\alpha_{21} = \left(\frac{dw}{ds} - \frac{w \tan\phi_2 \cos\alpha_{21}}{N_2} \right) d\alpha_{12} - \frac{\tan\phi_2 \sin\alpha_{21}}{N_2} ds \quad (9.3)$$

We now wish to solve equation (9.1), (9.2), and (9.3) for ds , $d\alpha_{12}$ and $d\alpha_{21}$ in terms of $d\phi_2$ and $d\lambda_2$. To do this we first multiply (9.1) by $\cos\alpha_{21}/N_2 \cos\phi_2$ and equation (9.2) by $\sin\alpha_{21}/M_2$. We then add the resulting equations to obtain:

$$ds = -M_2 \cos\alpha_{21} d\phi_2 - N_2 \cos\phi_2 \sin\alpha_{21} d\lambda_2 \quad (9.4)$$

We next multiply equation (9.1) by $\sin\alpha_{21}/N_2 \cos\phi_2$ and equation (9.2) by $-\cos\alpha_{21}/M_2$. We then add the resulting equations to obtain:

$$w d\alpha_{12} = M_2 \sin\alpha_{21} d\phi_2 - N_2 \cos\phi_2 \cos\alpha_{21} d\lambda_2 \quad (9.5)$$

If we substitute the value of ds and $d\alpha_{12}$ from (9.4) and (9.5) into (9.3) we find:

$$w d\alpha_{21} = M_2 \sin\alpha_{21} \frac{dw}{ds} d\phi_2 + N_1 \cos\phi_1 \cos\alpha_{12} d\lambda_2 \quad (9.6)$$

Having these three equations for the case where one point is free to move, we may develop formulas for the case where both end points are free to move. To do this we consider the end points originally at P_1 and P_2 moved by a small amount to T_1 and T_2 as shown in Figure 9.1.

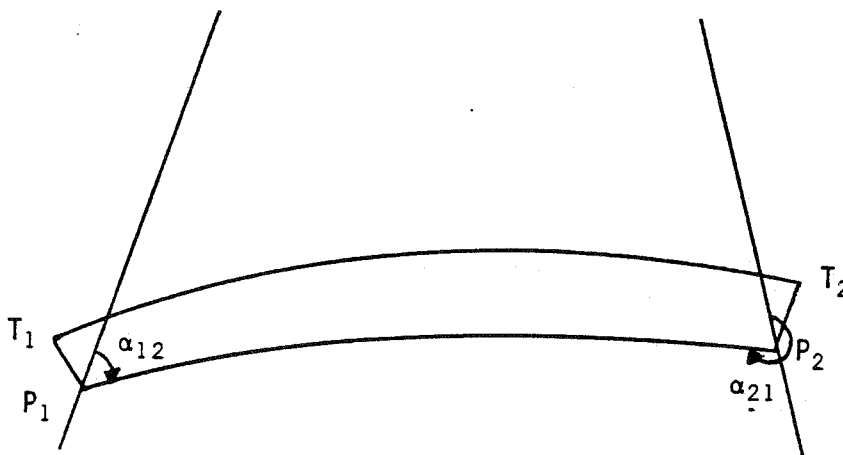

Figure 9.1
Differential Movements of Line Endpoints

First we consider P_2 moving to T_2 , resulting in changes in distances and azimuths of the lines designated as: $ds_a, d\alpha_{12a}, d\alpha_{21a}$. Such changes would be given by equations (9.4), (9.5), and (9.6) directly. We also move P_1 to T_1 causing additional changes $ds_b, d\alpha_{12b}, d\alpha_{21b}$. Ignoring higher order effects, the total displacement should be the sum of these two sets of displacements. Thus we set:

$$ds_t = ds_a + ds_b$$

$$d\alpha_{12t} = d\alpha_{12a} + d\alpha_{12b} \quad (9.7)$$

$$d\alpha_{21t} = d\alpha_{21a} + d\alpha_{21b}$$

Now the value of ds_a is given in equation (9.4). Using (9.4) the value of ds_b is:

$$ds_b = -M_1 \cos\alpha_{12} d\phi_1 - N_1 \cos\phi_1 \sin\alpha_{12} d\lambda_1$$

Thus:

$$ds_t = -M_2 \cos\alpha_{21} d\phi_2 - N_2 \cos\phi_2 \sin\alpha_{21} d\lambda_2 - M_1 \cos\alpha_{12} d\phi_1 - N_1 \cos\phi_1 \sin\alpha_{12} d\lambda_1 \quad (9.8)$$

However, we have by Clairaut's Theorem:

$$N_1 \cos \phi_1 \sin \alpha_{12} = -N_2 \cos \phi_2 \sin \alpha_{21}$$

so that (9.8) becomes:

$$ds_t = -M_2 \cos \alpha_{21} d\phi_2 - M_1 \cos \alpha_{12} d\phi_1 - N_2 \cos \phi_2 \sin \alpha_{21} (d\lambda_2 - d\lambda_1) \quad (9.9)$$

Equation (9.9) enables us to determine the required distance observation equation where the distances are considered to have been reduced to the ellipsoid.

We may calculate the change in azimuth at the first point by using (9.5) for $d\alpha_{12a}$, and equation (9.6) for $d\alpha_{21b}$ when applied at the first point. Thus:

$$d\alpha_{12b} = \frac{1}{w} [M_1 \sin \alpha_{12} \frac{dw}{ds} d\phi_1 + N_2 \cos \phi_2 \cos \alpha_{21} d\lambda_1] \quad (9.10)$$

Combining this with (9.5) we have:

$$d\alpha_{12t} = \frac{1}{w} [M_2 \sin \alpha_{21} d\phi_2 + M_1 \sin \alpha_{12} \frac{dw}{ds} d\phi_1 - N_2 \cos \phi_2 \cos \alpha_{21} (d\lambda_2 - d\lambda_1)] \quad (9.11)$$

Recall that the value of w may be found from equation (4.103) while dw/ds is found from equation (8.33).

Equation (9.11) is not a simple form for computation and attempts may be made at simplification for shorter length lines. The first simplification is that made by allowing the ellipsoid to become a sphere whose radius is the Gaussian mean radius at the first point. Then the expression for w becomes:

$$w = R \sin \frac{s}{R} \quad (9.12)$$

so that:

$$\frac{dw}{ds} = \cos \frac{s}{R} \quad (9.13)$$

We now insert (9.12) and (9.13) into (9.11) using $M_1 = M_2 = N_2 = R$ to find:

$$d\alpha_{12t} = \frac{\sin\alpha_{12}}{\tan \frac{s}{R}} d\phi_1 + \frac{\sin\alpha_{21}}{\sin \frac{s}{R}} d\phi_2 - \frac{\cos\phi_2 \cos\alpha_{21}}{\sin \frac{s}{R}} (d\lambda_2 - d\lambda_1) \quad (9.14)$$

If we expand the tangent and sine into a series and retain only the first term we have:

$$d\alpha_{12t} = \frac{R \sin\alpha_{12}}{s} d\phi_1 + \frac{R \sin\alpha_{21}}{s} d\phi_2 - \frac{R \cos\phi_2 \cos\alpha_{21}}{s} (d\lambda_2 - d\lambda_1) \quad (9.15)$$

Equation (9.15) would be an approximation to the correct differential relationship on the sphere, and an approximation to the differential relationship on the ellipsoid (i.e. equation (9.11)).

In order to develop the formula usually used in practice we modify (9.11) by assuming $w = s$ so that $dw/ds = 1$. Then (9.11) becomes:

$$d\alpha_{12t} \approx \frac{1}{s} (M_1 \sin\alpha_{12} d\phi_1 + M_2 \sin\alpha_{21} d\phi_2 - N_2 \cos\phi_2 \cos\alpha_{21} (d\lambda_2 - d\lambda_1)) \quad (9.16)$$

It is clear that (9.16) is only an approximation to the more precise result represented in (9.11). Olliver (1977) discusses the accuracy of equation (9.9) and (9.16) by comparing rigorously defined changes to the different results. For a line of 50 km in length the maximum azimuth error was 0.008" and the maximum distance error was 0.002 m when the given displacements were 0.15".

9.2 The Observation Equations

We now use the differential change formulas to develop the observation equations for distance and azimuth observations. We write a general observation equation in the form:

$$F(X_0) + \frac{\partial F}{\partial X} dX = L_{OBS} + v \quad (9.17)$$

where F is the function relating the observations, L_{OBS} , and the parameters, X , of the problem. dX are the corrections to the approximate values X_0 , of the parameters and v is the observation residual. From (9.17) we write:

$$v = F(X_0) - L_{OBS} + \frac{\partial F}{\partial X} dX \quad (9.18)$$

In section 9.1 we have developed the expressions for $\frac{\partial F}{\partial X} dX$. Thus for a distance observation we can write:

$$v_s = s_0 - s_{OBS} + ds_t \quad (9.19)$$

where ds_t is given by equation (9.9). In some cases a scale factor unknown (e.g. $s(k-k_0)$) may be added to this expression when scale inconsistencies in instruments and/or networks are suspected.

Next we consider the case where we observe a set of directions to various stations. After a station adjustment (Bomford, 1980, p. 30) has been performed, and after the corrections for skew normals, normal section to geodesic, and for the deflection of the vertical have been made, the directions are designated by $D_I, D_1 \dots D_i$ where D_I is the direction along an initial line. The geodetic azimuth of this initial line is α_I which may be only approximately known (α_{I0}) so we write:

$$\alpha_I = \alpha_{I0} + Z \quad (9.20)$$

where Z is known as the orientation or station correction. α_{I0} can be exactly computed given the approximate geodetic coordinates of the two points involved with the initial I line. The "observed" azimuth (α_i) for line i at the station would then be:

$$\alpha_i = \alpha_I + D_i - D_I = \alpha_{I0} + Z + D_i - D_I \quad (9.21)$$

Using α_i as the observed quantity in (9.18) we have:

$$v_i = \alpha_{i0} - (\alpha_{I0} + D_i - D_I) - Z + d\alpha_{12t}$$

where α_{i0} is the approximate azimuth along line i (computed from the approximate coordinates) and $d\alpha_{12t}$ would be given by equation (9.16) for example. In general, every station for which an approximate initial azimuth is used will have an orientation correction associated with it.

9.3 The Laplace Azimuth Observation Equation

Consider the Laplace azimuth as given by equation (7.27)

$$\alpha_L = A - (\Lambda - \lambda) \sin\phi \quad (9.22)$$

As only approximate values of λ are known α_L is subject to a correction found by differentiating (9.22) noting that A and Λ are observed quantities and that ϕ need only be approximately known.

$$d\alpha_L = d\lambda \sin\phi \quad (9.23)$$

Then we regard the "observed" geodetic azimuth to be as follows:

$$\alpha_{OBS} = \alpha_L + d\alpha_L \quad (9.24)$$

We then can write (9.18) as:

$$v = \alpha_0 - (\alpha_L + d\alpha_L) + d\alpha_{12t} \quad (9.25)$$

Using (9.16) and (9.23), (9.25) can then be written as:

$$v = \alpha_0 - \alpha_L + \frac{M_1 \sin\alpha_{12}}{S} d\phi_1 + \frac{M_2 \sin\alpha_{21}}{S} d\phi_2 - \frac{N_2 \cos\phi_2 \cos\alpha_{21}}{S} d\lambda_2 + \left(\frac{N_2 \cos\phi_2 \cos\alpha_{21}}{S} - \sin\phi_1 \right) d\lambda_1 \quad (9.26)$$

In (9.26) α_0 is computed using the approximate coordinates of the two points and α_L is computed from (9.22) using both observed and approximate coordinates. In the adjustment, the weight for the Laplace observation equation is determined considering the accuracy of A and Λ that enters into (9.26).

9.4 Alternate Observation Equation Forms

The techniques used in the previous sections are those generally associated with the adjustment of classical two dimensional geodetic networks. If a network is defined in three dimensions there is considerable simplification in the reduction procedure as points are now defined in space and no reductions (for either directions or distances) to the ellipsoid is needed. A review of various three-dimensional adjustment techniques has been given by Ashkenazi and Grist (1983).

A complete three dimensional adjustment procedure can be complicated by the need for astronomic information and height information. However the observation equations developed for a three dimensional adjustment can be used to derive new observation equations where astronomic quantities are considered known and height data is considered known or held fixed.

Bowring (1980) and Vincenty (1980b) discuss various aspects of the new adjustment process which is called a "height controlled network adjustment". One way to develop the new observation equations is to simply set height and astronomic coordinate corrections to zero. Then we have (Rapp, 1983, p. 156) for normal section directions (D_i):

$$v_D = A_0 - (A_{I0} + D_i - D_i) - Z + d_1 d\phi_1 + d_2 d\lambda_2 + d_4 d\phi_2 + d_5 d\lambda_2 \quad (9.27)$$

where A_{I0} is the approximate astronomic azimuth of an initial line. The observation equation coefficients are d_1 , d_2 , d_4 and d_5 . The chord distance equation would be:

$$v_c = c_0 - c_{OBS} + f_1 d\phi_1 + f_2 d\lambda_1 + f_4 d\phi_2 + f_5 d\lambda_2 \quad (9.28)$$

Bowring (1980) and Vincenty (1980) give the observation equation coefficients for the new models when the general form is written as follows:

$$v = F(X_0) - L_{OBS} + Fdu_1 + Gdv_1 - \bar{F}du_2 - \bar{G}dv_2 \quad (9.29)$$

where:

$$\begin{aligned} du &= (M + h) d\phi \\ dv &= (N + h) \cos\phi d\lambda \end{aligned} \quad (9.30)$$

There are a number of advantages to the height controlled system over that used classically for many years. Perhaps the most important is that no reductions are performed on the observations to reduce them to the ellipsoid. The azimuths are considered with respect to the direction of the gravity vector and the distances are considered as chords between the stations. A secondary advantage is that the computational effort is reduced in the newer models as fewer trigonometric functions are needed.

10. GEODETIC DATUMS AND REFERENCE ELLIPSOIDS

10.1 Datum Development

The purpose of this chapter is to briefly introduce the topic of geodetic datums and to consider their use and unification today. Procedures for the actual definition of datums and the determination of the ellipsoid parameters is described in Rapp (1983).

Historically, geodetic datums have been needed for the development of geodetic networks. These datums usually provided an initial point (ϕ_0, λ_0), an initial azimuth (α_0) for orientation purposes, and the ellipsoid parameters. There are a total of five parameters needed for this simple definition of a geodetic datum.

As need for geodetic control grew, various countries developed their own geodetic datums. As more complete and reliable data was obtained, new and more accurate geodetic datums were defined. Some datums were defined with ellipsoid parameters that would make astro-geodetic deflections small in a country. Small datums (for example on islands) were defined only through astronomic coordinates with the ellipsoid parameters being taken from an unrelated source.

The location of nine major geodetic datums is shown in Figure 10.1. A more complete datum location map may be found in DMAHTC publication (1982). A list of 58 geodetic datums is given in Rapp (1983).

The determination of ellipsoid parameters has been actively carried out since the 19th century. The techniques for these computations have used a great variety of data including the analysis of triangulation networks, gravity variations, satellite derived station positions, and satellite altimetry. In 1909 the formal accuracy in the determination of the equatorial radius was on the order of 18 m (Hayford, 1910) although the computed value was in error by 252 m. Today, using a variety of measurement techniques the equatorial radius of the earth is known to about ± 1 m. At this level of accuracy and better it becomes important to have precise definitions of what is meant by ellipsoid parameters. Such definitions are described in Rapp (1983). Table 9.1 gives parameters of the various ellipsoids used in the past and those that are current. In some cases the flattening is not specifically defined but is derived from other quantities. For example, the Clarke 1866 ellipsoid parameters are defined in terms of a and b . The flattening for the Geodetic Reference System ellipsoids is derived from other data, primarily the second degree zonal harmonic of the earth's gravitational field that is accurately defined through the analysis of satellite motions. The estimates listed in this table for the International Association of Geodesy are best estimates as of the data given. They are not used for the definition of new sets of constants.

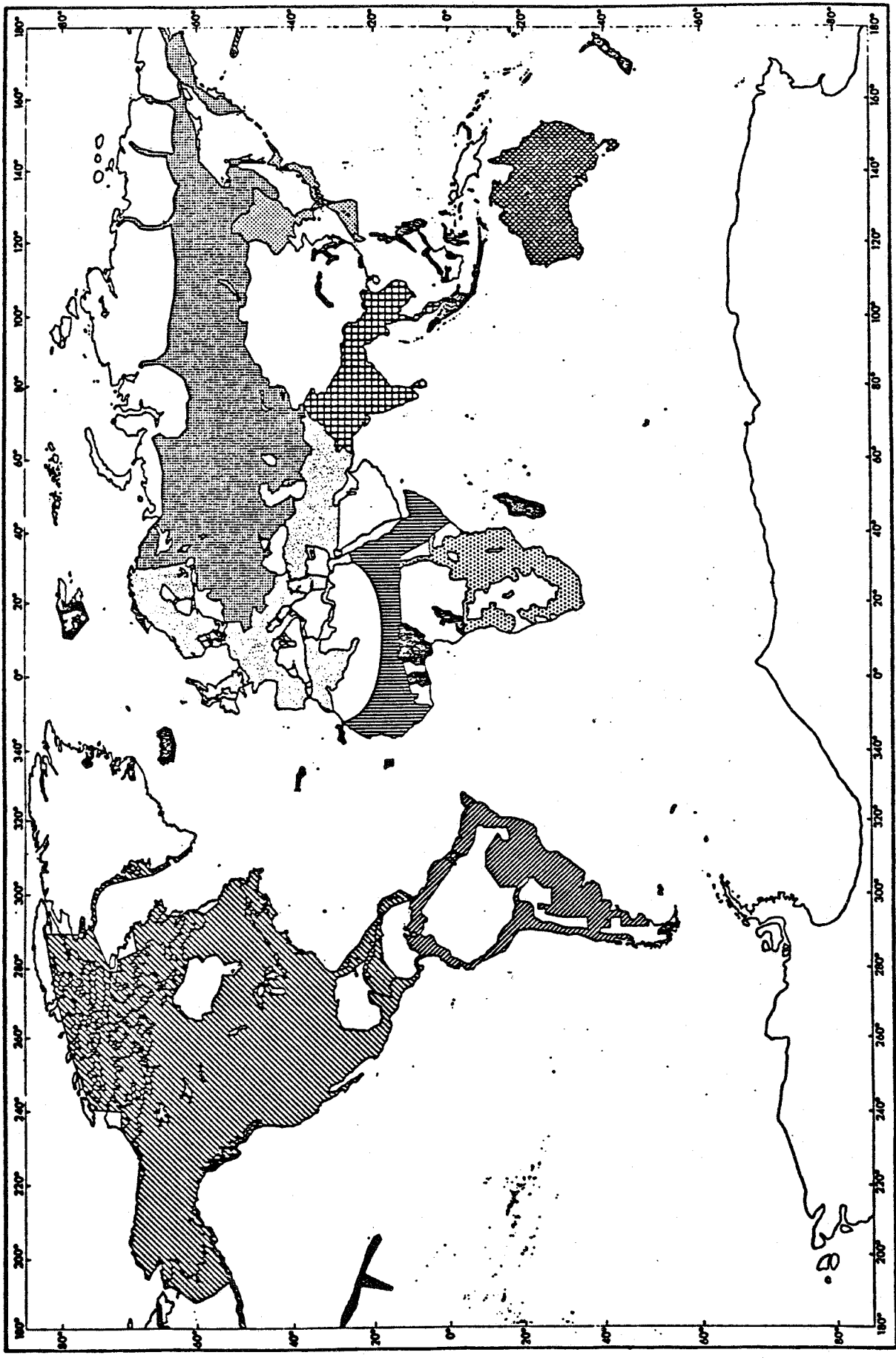

DATUMS









-  North American
-  European
-  Tokyo
-  Cape (Arc)
-  Adindān
-  Indian
-  Australian National
-  Pulkovo 42
-  South American
-  Independent

Figure 10.1
Major Geodetic Datum Blocks

(from NASA Directory of Station Locations 5th ed. 1978, Computer Sciences Corp.)

Table 10.1
Ellipsoid Parameters

<u>Ellipsoid</u>	<u>Semi-Major Axis</u>	<u>Inverse Flattening</u>
Name (Year Computed)	a(m)	1/f
Airy (1830)	6377563.396	299.324964
Bessel (1841)	6377397.155	299.152813
Clarke 1866	6378206.4	294.978698
Clarke 1880 (modified)	6378249.145	293.4663
Clarke 1880	6378249.145	293.465
Everest (1830)	6377276.345	300.8017
International (1924)	6378388	297
Krassovski (1940)	6378245	298.3
Mercury 1960	6378166	298.3
Modified Mercury 1968	6378150	298.3
Australian National	6378160	298.25
South America 1969	6378160	298.25
Geodetic Reference System 1967	6378160	298.2471674273
WGS72	6378135	298.26
Int. Assoc. of Geodesy (1975)	6378140 ±5	298.257 ±.0015
Geodetic Reference System 1980	6378137	298.257222101
Int. Assoc. of Geodesy (1983)	6378136 ±1	298.257
WGS84	6378137	298.257223563
Int. Assoc. of Geodesy (1987)	6378136	

10.2 Datum Transformation

A recognized goal of geodesy has historically been to obtain geodetic coordinates on one common system. With so many geodetic datums in the world this is a difficult procedure. However, using satellite techniques it is possible to determine the rectangular coordinates of points in a defined coordinate system that is close to being geocentric. If a set of ellipsoid parameters are defined these rectangular coordinates can be converted to a latitude, longitude and height above the reference ellipsoid. If we make satellite observations on a point whose coordinates are defined in a specific datum we can compare the satellite coordinates and the datum coordinates to obtain a connection between the two systems.

For simplicity we assume that our datum coordinate system and the satellite system have a different center but have their X, Y, Z axes parallel as shown in Figure 10.2.

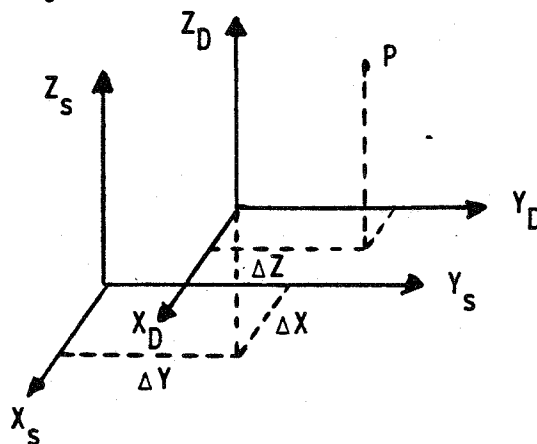

Figure 10.2

A Satellite (S) and Datum(D) System with Parallel Axes

Consider the rectangular coordinates of point P in the datum system. Such quantities can be computed from equation (3.152) where h is the sum of the orthometric height (H) and the astro-geodetic undulation (N_{AG}):

$$\begin{aligned} X_D &= (N + H + N_{AG}) \cos\phi \cos\lambda \\ Y_D &= (N + H + N_{AG}) \cos\phi \sin\lambda \\ Z_D &= (N(1-e^2) + H + N_{AG}) \sin\phi \end{aligned} \quad (10.1)$$

We let ΔX , ΔY , ΔZ be the datum shifts with respect to the satellite system so that:

$$X_S = X_D + \Delta X$$

$$Y_S = Y_D + \Delta Y \tag{10.2}$$

$$Z_S = Z_D + \Delta Z$$

Given a sufficient number of stations where the coordinates are determined in both systems the datum shifts can be obtained. If we then go to an arbitrary point and find the satellite coordinates we can subtract the datum shifts to obtain the rectangular coordinates in the datum system. These coordinates can then be converted to geodetic coordinates using the procedures described in section 6.8 where the datum ellipsoid parameters are used.

The datum conversion model represented by the equation (10.2) is based on the assumption that the axes of the two systems are parallel and the systems have the same scale, and the geodetic network has been consistently computed. In reality none of these assumptions are true so that the ΔX , ΔY , ΔZ values can vary from point to point as shown by Leick and van Gelder (1975) for the United States. A more general transformation involves seven parameters which are three translations, three rotations representing the non-parallelity of the axes of the two systems and a scale factor representing the scale difference between the two systems. This more general transformation can be represented as follows:

$$\begin{pmatrix} X \\ Y \\ Z \end{pmatrix}_S = \begin{pmatrix} X \\ Y \\ Z \end{pmatrix}_D + \begin{pmatrix} \Delta X \\ \Delta Y \\ \Delta Z \end{pmatrix} + \begin{pmatrix} X \\ Y \\ Z \end{pmatrix}_D \Delta L + \begin{pmatrix} 0 & \omega_z & -\omega_y \\ -\omega_z & 0 & \omega_x \\ \omega_y & -\omega_x & 0 \end{pmatrix} \begin{pmatrix} X \\ Y \\ Z \end{pmatrix}_D \tag{10.3}$$

In this equation ΔL is a scale difference parameter and ω_x , ω_y , ω_z are rotations about the X, Y, Z datum axes to bring them parallel to the satellite axes. The development of equation (10.3) and applications of this transformation are discussed in Rapp (1983).

If we are willing to adopt the simplified transformation model represented by equation (10.2) values of the datum shifts are available to go to the World Geodetic System 1972 (Seppelin, 1974a,b). Table 10.2 gives three shifts as taken from Seppelin (1974b). WGS1972 has now been super-ceded by WGS84 (DMA, 1987). Table 10.3 gives the three datum origin shifts for selected datums to go from the local system to WGS84.

Table 10.2
Datum Shift Constants
(Geodetic Datum to WGS 72)
(from Seppelin, 1974b)

Geodetic Datums and Reference Ellipsoids	Constants				
	$\Delta X(m)$	$\Delta Y(m)$	$\Delta Z(m)$	$\Delta a(m)$	$\Delta f \times 10^{-4}$
North American 1927 (Clarke 1866)	- 22*	157*	176*	- 71.400	-0.37295850
Alaska and Canada	- 9	139	173	- 71.400	-0.37295850
European (International)	- 84	-103	-127	-253.000	-0.14223913
Tokyo (Bessel)	-140	516	673	737.845	0.10006272
Australian Geodetic (Australian National)	-122	- 41	146	- 25.000	-0.00112415
Ordnance Survey of Great Britain 1936 (Airy)	368	-120	425	571.604	-0.11928812
South American 1969 (South American 1969)	- 77	3	- 45	- 25.000	-0.00112415
Old Hawaiian (Clarke 1866)					
Maui	65	-272	-197	- 71.400	-0.37295850
Oahu	56	-268	-187	- 71.400	-0.37295850
Kauai	46	-271	-181	- 71.400	-0.37295850
Johnston Island Astro 1961 (International)	192	- 59	-211	-253.000	-0.14223913
Wake-Eniwetok 1960 (Hough)					
Kwajalein Atoll	112	68	- 44	-135.000	-0.14223913
Wake Island	121	62	- 22	-135.000	-0.14223913
Eniwetok Atoll	144	62	- 38	-135.000	-0.14223913

*Mean value for the NAD 27 area excluding Alaska and Canada; see also Figures 6, 7, and 8.

Table 10.2 (cont'd)
Datum Shift Constants
(Geodetic Datum to WGS 72)

Geodetic Datums and Reference Ellipsoids	Constants				
	$\Delta X(m)$	$\Delta Y(m)$	$\Delta Z(m)$	$\Delta a(m)$	$\Delta f \times 10^{-4}$
Wake Island Astro 1952 (International)	283	- 44	141	-253.000	-0.14223913
Canton Island Astro 1966 (International)	294	-288	-382	-253.000	-0.14223913
Guam 1963 (Clarke 1866)	- 89	-235	254	- 71.400	-0.37295850
Ascension Island Astro 1958 (International)	-214	91	48	-253.000	-0.14223913
South Asia (Fischer 1960)	21	- 61	- 15	- 20.000	0.00449585
Nanking 1960 (International)	-131	-347	0	-253.000	-0.14223913
Arc 1950 (Clarke 1880)	-129	-131	-282	-114.145	-0.54781925
Adindan (Clarke 1880)	-152	- 26	212	-114.145	-0.54781925
Mercury 1960 (Fischer 1960)					
NAD 27 Area	- 25	46	- 49	- 31.0	0.00449585
ED Area	- 13	- 88	- 5	- 31.0	0.00449585
TD Area	18	-132	60	- 31.0	0.00449585
Modified Mercury 1968 (Fischer 1968)					
NAD 27 Area	- 4	12	- 7	- 15.0	0.00449585
ED Area	- 3	1	- 6	- 15.0	0.00449585
TD Area	22	34	2	- 15.0	0.00449585

Table 10.3

**Transformation Parameters
Local Geodetic Systems to WGS84
(from DMA TR 8350.2, 1987)***

Geodetic Datums and Reference Ellipsoids	Constants				
	ΔX (m)	ΔY (m)	ΔZ (m)	Δa (m)	$\Delta f \times 10^4$
Arc 1950 (Clarke 1880)	-143	-90	-294	-112.45	-.54750714
Australian Geodetic 1984 (Australian National)	-134	-48	149	-23	-.00081204
Cape (Clarke 1880)	-136	-108	-292	-112.45	-.54750714
European 1950 (International)	-87	-98	-121	-251	-.14192702
Indian (Everest)	214	836	303	860.655	.28361368
North American 1927 (Clarke 1866)	-8	160	176	-69.4	-.37264639
South American 1969 (South American 1969)	-57	1	-41	-23	-.00081204
Tokyo (Bessel 1841)	-128	481	664	739.845	.10037483

* Department of Defense World Geodetic System 1984, Its Definition and Relationship with Local Geodetic Systems, DMA TR 8350.2, Washington, D.C., 1987.

References

- Ashkenazi, V., Models for Controlling National and Continental Networks, Bulletin Geodesique, 55, 1981.
- Ashkenazi, V., and S. Grist, 3-D Geodetic Network Adjustment Models: Significance of Different Approaches, in Proc. 1983 General Assembly, International Association of Geodesy, published by Department of Geodetic Science and Surveying, The Ohio State University, Columbus, 1984.
- Badi, K., Report on the Program Bowring Short Lines, Direct and Inverse, Department of Geodetic Science and Surveying, The Ohio State University, 1983.
- Baeschlin, C.F., Textbook of Geodesy, Orell Füssli Verlag, Zurich, 1948.
- Bagratuni, G.V., Course in Spheroidal Geodesy, 1962, translated from Russian, Translation Division, Foreign Technology Division, Wright-Patterson AFB, Ohio AD65 520, 1967.
- Bartelme, N. and P. Meissl, Ein einfaches, rasches und numerisch stabiles Verfahren zur Bestimmung des kürzesten Abstandes eines Punktes von einem sphäroidischen Rotationsellipsoid, Allgemeiner Vermessungsnachrichten, Vol. 12, pp. 436-439, 1975.
- Bomford, G., Geodesy, Oxford at the Clarendon Press, 4th edition, 1980.
- Bowring, B., Transformation from Spatial to Geographical Coordinates, Survey Review, XXIII, 181, pp. 323-327, 1976.
- Bowring, B., Notes on Space Adjustment Coefficients, Bulletin Geodesique, 54, 191-200, 1980.
- Bowring, B.R., The Direct and Inverse Problems for Short Geodesic Lines on the Ellipsoid, Surveying and Mapping, Vol. 41, No. 2, 135-141, 1981.
- Bowring, B.R., The Direct and Inverse Solutions for the Great Elliptic Arc, Bulletin Geodesique, Vol. 58, 1984.
- Carroll, D., and C. Wessells, A 1975 Astrogeodetic Geoid for the United States, presented at the XVI General Assembly, International Association of Geodesy, Grenoble, France, 1975.
- Clarke, A.R., Geodesy, Oxford at the Clarendon Press, 1880.
- Clark, David, Plane and Geodetic Surveying, Volume Two: Higher Surveying, Constable and Co. Ltd, London, 1957.
- DMA, Index of Grids, Datums and Spheroids, 1982, prepared by the Defense Mapping Agency Hydrographic/Topographic Center, Washington, D.C. 20315, in Grids and Grid References, Technical Manual TM 5-241-1, Dept. of the Army, Washington, D.C., 25 March 1983.

- Fischer, I., et al, Geoid Charts of North and Central America, Army Map Service Technical Report No. 62, Washington, D.C., October 1967.
- Fischer, I., The Figure of the Earth - Changes in Concepts, Geophysical Surveys, 2, 3-54, 1975a.
- Fischer, I., Another Look at Eratosthenes' and Posidonius' Determinations of the Earth's Circumference, Q. Jl. R. Astr. Soc., 16, 152-167, 1975b.
- Gan'shin, V.N., Geometry of the Earth Ellipsoid, Nedra Publishers, 1967, translated from Russian, 1969, ACIC-TC-1473, AD 689507, available from Clearinghouse, Springfield, Virginia 22151.
- Grafarend, E., and B. Richter, The Generalized Laplace Condition, Bulletin Geodesique, 51, 287-293, 1977.
- Grushinskiy, N.P., The Theory of the Figure of the Earth, 1963, translated from Russian, 1969, FTD-HT-23-313-68, AD694748, available from Clearinghouse, Springfield, Virginia 22151.
- Gupta, R.M., A Comparative Study of Various Direct and Inverse Formulae for Lines up to 800 km in Ellipsoidal Geodesy, M.S. thesis, The Ohio State University, 1972.
- Hayford, J., Supplementary Investigation in 1909 of the Figure of the Earth and Isostasy, U.S. Coast and Geodetic Survey, Washington, D.C., 1910.
- Heikkinen, M., Geschlossene Formeln zur Berechnung räumlicher geodätischer Koordinaten aus rechtwinkligen Koordinaten, Zeitschrift für Vermessungswesen, Vol. 5, 207-211, 1982.
- Heiskanen, W., and H. Moritz, Physical Geodesy, W.A. Freeman, San Francisco, 1967.
- Helmert, F.R., Die Mathematischen Und Physikalischen Theorien Der Höheren Geodäsie, B.G. Teubner, Leipzig, 1880 (reprinted 1962), (translation by Aeronautical Chart and Information Center, St. Louis, 1964).
- Hirvonen, R., and H. Moritz, Practical Computations of Gravity at High Altitudes, Report No. 27, Institute of Geodesy, Photogrammetry and Cartography, The Ohio State University, Columbus, 1963.
- Hosmer, G., Geodesy, John Wiley and Sons, New York, second edition, 1930.
- Howse, D., Greenwich Time and the discovery of the longitude, Oxford University Press, Oxford, England, 1980.
- Jordan-Eggert, Jordan's Handbook of Geodesy, translation of 8th edition, 1941 by Martha W. Carta, (U.S. Army Map Service, Washington, D.C., 1962).

- Lambert, W.D., and C. Swick, Formulas and Tables for the Computation of Geodetic Positions on the International Ellipsoid, Special Publication No. 200, U.S. Coast and Geodetic Survey, Washington, D.C., 1935.
- Lauf, G., Geodesy and Map Projections, TAFE Publications Unit, 37 Longridge St., Collingwood, Victoria 3066, Australia, 1983.
- Leick, A., and B. van Gelder, On Similarity Transformations and Geodetic Network Distortions Based on Doppler Satellite Observations, Report No. 235, Department of Geodetic Science, The Ohio State University, Columbus, 1975.
- Lewis, E.A., Parametric Formulas for Geodesic Curves and Distances on a Slightly Oblate Earth, Air Force Cambridge Research Laboratories, Note No. 63-485, April, 1963, AD412 501.
- Meade, B.K., Comments on Formulas for the Solution of Direct and Inverse Problems on Reference Ellipsoids Using Pocket Calculators, Surveying and Mapping, Vol. 41, No. 1, 1981.
- Moose, E.R. and S.W. Henriksen, Effect of Geociever Observations Upon the Classical Triangulation Networks, NOAA Technical Report, NOS 66 NOS2, Rockville, Maryland, 1976.
- Moritz, H., The Definition of a Geodetic Datum, in Proc., Second Int. Symposium on Problems Related to the Redefinition of North American Geodetic Networks, Supt. of Documents, U.S. Govt. Printing Office, Stock No. 003-017-0426-1, Washington, D.C. 20402.
- Mueller, I., Spherical and Practical Astronomy as Applied to Geodesy, F. Ungar Publishing Co., New York, 1969.
- Mueller, I., Reference Coordinate Systems for Earth Dynamics. A Preview, in Proc. Reference Coordinate Systems for Earth Dynamics, D. Reidel Publishing Co., Boston, 1981.
- Olliver, S.G., Observation Equations for Observed Directions and Distances in Spheroidal Co-ordinates, Survey Review, XXIV, 184, 71-77, 1977.
- Paul, M.K., A Note on Computation of Geodetic Coordinates from Geocentric (Cartesian) Coordinates, Bulletin Geodesique, No. 108, 135-139, June 1973.
- Petty, J.E., and W.E. Carter, Uncertainties of Astronomic Positions and Azimuth, in Proc., Second Int. Symp. on Problems Related to the Redefinition of North American Geodetic Networks, NOAA, Stock No. 003-017-0426-1, Superintendent of Documents, Washington, D.C. 20402.
- Pick, M., J. Picha, and V. Vyskocil, Theory of the Earth's Gravity Field, Elsevier Scientific Publishing Co., New York, 1973.
- Rapp, R.H., Geometric Geodesy, Volume II (Advanced Techniques), Department of Geodetic Science and Surveying, The Ohio State University, Columbus, 1983.

- Robbins, A.R., Geodetic Astronomy in the Next Decade, Survey Review, XXIV, 185, 99-108, 1977.
- Schwarz, C., Deflections of the Vertical, ACSM Bulletin, 65, 17-18, May 1979.
- Seppelin, T., The Department of Defense World Geodetic System 1972, The Canadian Surveyor, Vol. 28, No. 5, 496-506, 1974a.
- Seppelin, T., The Department of Defense World Geodetic System 1972, presented at the International Symposium on Problems Related to the Redefinition of North American Geodetic Networks, University of New Brunswick, Fredericton, New Brunswick, 1974b.
- Thomson, D.B., and P. Vaniček, Note on the Reduction of Spatial Distances to a Reference Ellipsoid, Survey Review, XXII, 173, 309-312, 1974.
- Tobey, W.M., Geodesy, Publication 11, Geodetic Survey of Canada, Ottawa, 1928.
- Vaniček, P., and E. Krakiwsky, Geodesy, the Concepts, North-Holland Publishing Co., New York, 1982.
- Vaniček, P., and G. Carrera, How much does reference ellipsoid misalignment affect deflection components and geodetic azimuth, Canadian Surveyor, 1983.
- Vincenty, T., A Note on the Reduction of Measured Distances to the Ellipsoid, Survey Review, XXIII, No. 175, 40-42, 1975.
- Vincenty, T., Closed Formulas for the Direct and Reverse Geodetic Problems, Bulletin Geodesique, 51, 241-242, 1977.
- Vincenty, T., Zur räumlich-ellipsoidischen Koordinaten-Transformation, Zeitschrift für Vermessungswesen, Vol. 11, No. 105, pp. 519-521, 1980a.
- Vincenty, T., Height Controlled Three-Dimensional Adjustment of Horizontal Networks, Bulletin Geodesique, 54, 37-43, 1980b.
- Vincenty, T., Methods of Adjusting Space Systems Data and Terrestrial Measurements, Bulletin Geodesique, 56, 231-241, 1982.
- Vincenty, T., On the Role of Rotation Angles in Geodetic Problems, unpublished manuscript, 6 March 1983.
- Wenzel, H.-G., An Astrogeodetic Geoid Around the North Sea, in Report No. 80, Wissenschaftliche Arbeiten der Lehrstühle für Geodäsie, Photo., und Kart., Technischen Universität Hannover, Hannover: FRG, 1978.
- Zakatov, P.S., A Course in Higher Geodesy, translated from Russian 1962, by Israel Program for Scientific Translation, for National Science Foundation, OTS 61-31212.